

---

*Comfort-Cire*®

**Century**®

**MARS**®  
Delivering Confidence

---

## Installation Manual

# 7602-457

### Communicating, Programmable Thermostat

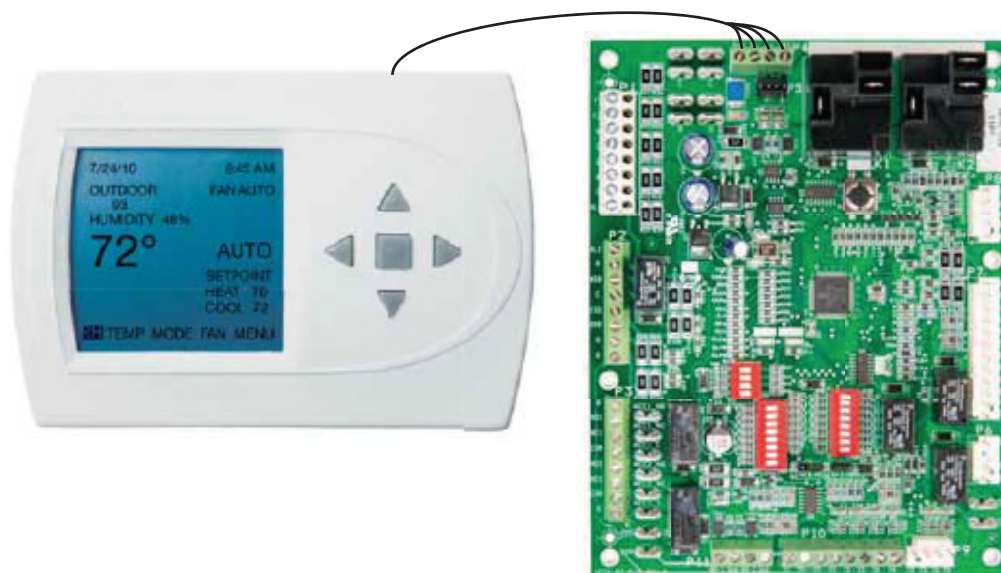

**Caution:**

These instructions are intended to be used by the installer or service personnel. End users are NOT advised to change or modify any of these settings. Doing so may cause the equipment to stop working properly and/or may void the warranty on both the thermostat and the equipment.

## Table of Contents

Section	Title	Page	Section	Title	Page
	Safety/Installation Considerations	3	4.4	Air Cleaner	10
1.0	User Menu Settings	4	5.0	Input Dealer Information	10
2.0	Installer Menu Settings	6	6.0	Humidity Configuration	11
2.1	Installer Menu Settings Access	6	7.0	Temperature Algorithm	11
2.2	Thermostat Configuration	6	8.0	Demand Reduction Configuration	12
3.0	System Configuration	7	9.0	Service Mode	12
3.1	Airflow Selection	7	9.1	Manual Operation	12
3.2	Option Selection	7	9.2	Control Diagnostics	12
3.3	Unit Configuration	8	9.3	Dipswitch Configuration	13
3.4	Pump Configuration	8	9.4	Fault History	13
3.5	Valve Configuration	9	9.5	Clear Fault History	14
3.6	Multi-Unit Configuration	9	9.6	Multi-Unit Diagnostics	14
4.0	Accessory Configuration	10	9.7	Multi-Unit Fault Information	15
4.1	Air Filter	10	10.0	Restore Defaults	15
4.2	Humidifier	10	11.0	Revision History	16
4.3	UV Lamp	10			

Comfort-Aire and Century's 7602-457 Communicating, Programmable Thermostat is the perfect compliment to a Comfort-Aire and Century's Geothermal Heat Pump System and represents a significant advancement in thermostat communicating technology. For homeowners, the 7602-457 provides highly customizable climate control features designed to maximize comfort and reduce the amount of energy consumed by the Comfort-Aire or Century Geothermal Heat Pump System. For dealers, it represents a significant, industry leading advancement in configuration, monitoring and diagnostics from the thermostat. Please read the following instructions carefully to maximize the comfort and cost-saving potential of your Comfort-Aire or Century Geothermal Heat Pump System.

## SAFETY CONSIDERATIONS

Improper wiring or installation may damage thermostat. Wiring must conform to local and national electrical codes

### ⚠ WARNING! ⚠

**WARNING!** Before installing thermostat, turn off all power to unit. There may be more than one power disconnect. Electrical shock can cause personal injury or death.

## INSTALLATION CONSIDERATIONS

The thermostat requires no batteries. The thermostat is not a power stealing device and MUST have both R and C terminals connected. See Diagram 1.

### INSTALLATION

#### I. THERMOSTAT LOCATION

Thermostat should be mounted:

- Approximately 5 ft. (1.5m) above floor.
- Close to or in a frequently used room, preferably on an inside partitioning wall.
- On a section of wall without pipes or duct work.

Thermostat should NOT be mounted:

- Close to a window, on an outside wall, or next to a door leading to the outside.
- Exposed to direct light and heat from a lamp, sun, fireplace, or other temperature-radiating object which may cause a false reading.
- Close to or in direct airflow from supply registers.
- In areas with poor air circulation, such as behind a door or in an alcove.

#### II. THERMOSTAT INSTALLATION

1. Turn off all power to unit.
2. If an existing thermostat is being replaced:
  - A. Remove existing thermostat from wall.
  - B. Disconnect wires from existing thermostat, one at

a time. Be careful not to allow wires to fall back into the wall.

- C. As each wire is disconnected, record wire color and terminal marking.
- D. Discard or recycle old thermostat.

**NOTE:** Mercury is a hazardous waste and MUST be disposed of properly.

3. Separate the thermostat from base.
4. Route thermostat wires through hole in base. Level base against wall (for aesthetic value only - thermostat need not be leveled for proper operation) and mark wall through 2 mounting holes.
5. Drill two 3/16-in. mounting holes in wall where marked. (Note: Mounting holes on thermostat are designed to fit on a horizontal J-box).
6. Secure base to wall with 2 anchors and screws provided making sure all wires extend through hole in base.
7. Connect wires to proper terminal of the connector block in the thermostat.
8. Push any excess wire back into wall. Excess wire inside the thermostat case can interfere with proper air flow across the temperature sensor. Seal hole in wall to prevent air leaks. Leaks can affect operation.
9. Install thermostat on base.
10. Turn on power to the unit.

### III. WIRING DIAGRAMS

All excess wire should be pushed back into the wall as far as possible. Excess wire inside the thermostat plastic case may interfere with the air flow across the temperature sensor.

Diagram 1: Thermostat Connections

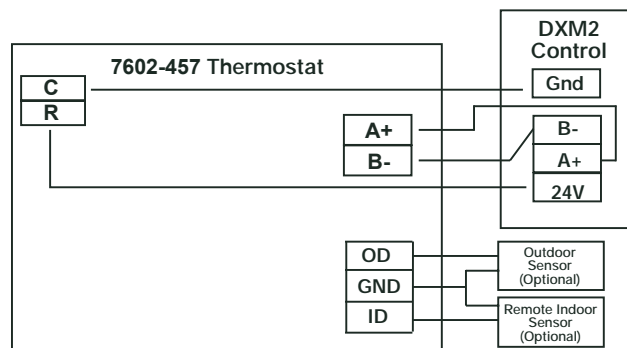

#### Thermostat Connections

- C 24V Common for Control Circuit
- R 24V Supply for Control Circuit
- A+ Communications (Positive)
- B- Communications (Negative)
- GND Ground
- OD Outdoor Temperature Sensor
- ID Indoor Temperature Sensor

## 1.0 User Menu Settings

### 1.1 OFFSETS

If you find that the temperature displayed on the thermostat does not accurately represent the room temperature where the thermostat is located, this offset function compensates for the difference. The thermostat will apply an offset between what temperature the thermostat is measuring versus the temperature that is displayed.

#### 1.1.1 TEMPERATURE OFFSET

The Temperature Offset function allows for calibration of the temperature sensor.

Adjust the Temperature Offset settings using the up/down arrow buttons. Press the center button to save changes.

- **Indoor Temperature (default 0°F):** options: -5°F to +5°F (in 1°F increments)
- **Remote Temperature (default 0°F):** options: -5°F to +5°F (in 1°F increments)
- **Outdoor Temperature (default 0°F):** options: -5°F to +5°F (in 1°F increments)
- **1st Stage (default 1°F):** options: 1°F to 4°F (in 1°F increments)
- **2nd Stage (default 1°F):** options: 1°F to 4°F (in 1°F increments)
- **Aux Heat (default 1°F):** options: 1°F to 4°F (in 1°F increments)

**NOTE 1:** The thermostat must be configured for Multistage by installer to access the 2nd Stage Differential setting. The thermostat must be configured for Auxiliary Heat by installer to access the Auxiliary Heat Differential setting.

**NOTE 2:** The temperature control algorithm must be configured for Differential control to access the Differential settings by installer.

#### 1.1.2 HUMIDITY OFFSET

If you find that the Humidity level displayed on the thermostat does not accurately represent the Humidity level of the room in which the thermostat is located, use the Humidity Offset function to calibrate the humidity sensor.

Adjust the Humidity Offset setting using the up/down arrow buttons. Press the center button to save changes.

- **Indoor Humidity (default 0%):** options: -10% to +10% (in 1% increments)

### 1.2 AUTO CHANGEOVER TIME

When the thermostat is configured for AUTO mode, the thermostat automatically selects heating or cooling mode depending on the indoor temperature.

The Auto Changeover Time is the amount of time that elapses before operation switches from heating to cooling mode or from cooling to heating mode.

Adjust the Auto Changeover Time using the up/down arrow buttons. Press the center button to save changes.

- **Auto Change Over Time (default 15 minutes):** options: 0 to 120 minutes (in 15 minute increments)

### 1.3 DEMO MODE

Demo mode is designed to showcase heat pump operation when the unit is connected to an above ground water loop with the supply air being blown directly over the water loop.

#### 1.3.1 ENTER DEMO MODE

To enter Demo Mode, navigate to the Service Information screen (Menu>Settings>Service Information) then press and hold the right arrow for 5 seconds

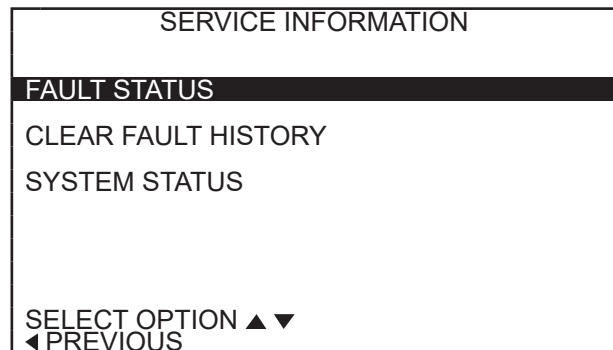

#### 1.3.2 DEMO MODE OPERATION

Control Demo Mode operation parameters from the Demo Operation screen shown below.

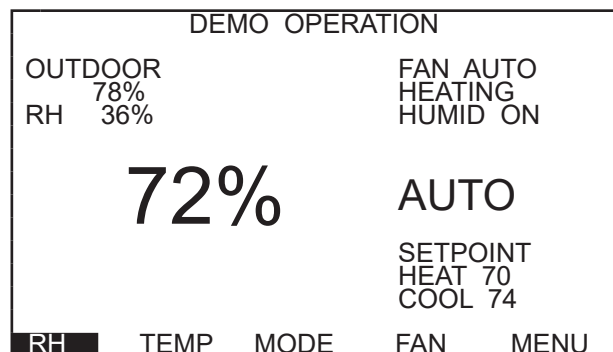

The starting mode (heating or cooling) depends on the loop temperature at the time when Demo Mode is entered. The unit will operate in heating or cooling based upon the following algorithm.

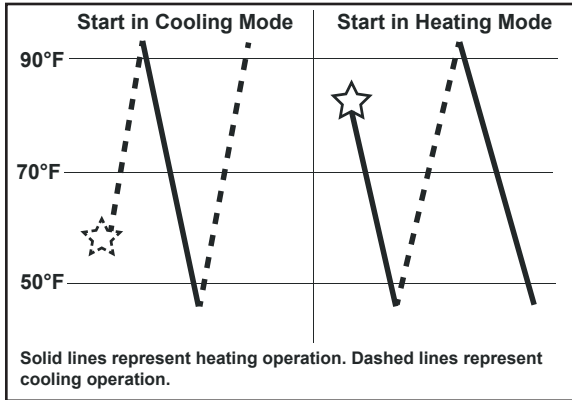

### 1.3.3 EXITING DEMO MODE

To exit demo mode, remove power to the thermostat.

## 2.0 Installer Menu Settings

### 2.1 INSTALLER MENU SETTINGS ACCESS

The Installer Settings can be accessed at any time from the Main Operating screen by holding the up/down arrows simultaneously for 5 seconds while the thermostat is in OFF Mode.



### Installer Menu Settings Overview

- Thermostat Configuration
- System Configuration
  - Airflow Selection
  - Option Selection
  - Unit Configuration
  - Pump Configuration
  - Valve Configuration
- Accessory Configuration
  - Air Filter
  - Humidifier
  - UV Lamp
  - Air Cleaner
- Input Dealer Information
- Humidity Configuration
- Temperature Algorithm
- Demand Reduction Configuration
- Service Mode
  - Manual Operation
  - Control Diagnostics
  - Dipswitch Configuration
  - Fault History
  - Clear Fault History
- Restore Defaults

### 2.2 THERMOSTAT CONFIGURATION

Upon initial power up, the communicating thermostat will prompt the installer for the thermostat configuration settings.

Model number and software version of thermostat and software version of connected DXM2 are also displayed on this screen.

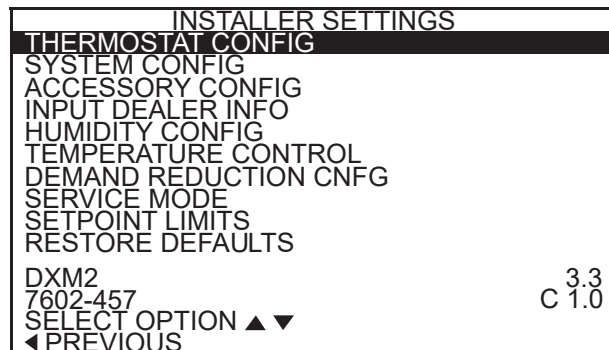

### 2.2.1 STAGING

Adjust the staging option using the up/down arrow buttons. Press the center button to save changes.

- **Single Stage** – for control of a single stage compressor applications
- **Multi-Stage (default)** – for control of multi-stage compressor applications

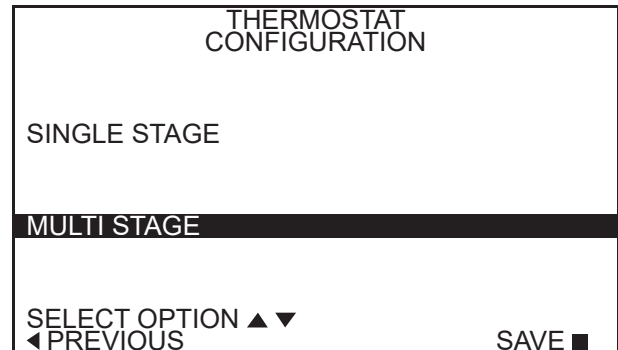

### 2.2.2 AUXILIARY HEAT

Adjust the Auxiliary Heat options using the up/down arrow buttons. Press the center button to save changes.

- **Electric (default)** – for control of a system with electric auxiliary heat
- **Multi-Fuel** – for control of a system with furnace for auxiliary heat
- **No Auxiliary Heat** – for control of a system with no auxiliary heat

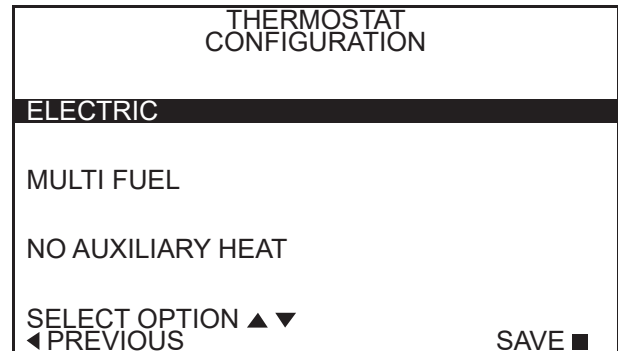

#### 2.2.2.1 AUXILIARY HEAT CONFIGURATION

Select Electric Auxiliary Heat mode

- **Auxiliary Heat to Supplement Pump**
- **Auxiliary Heat for Emergency Heat Only**

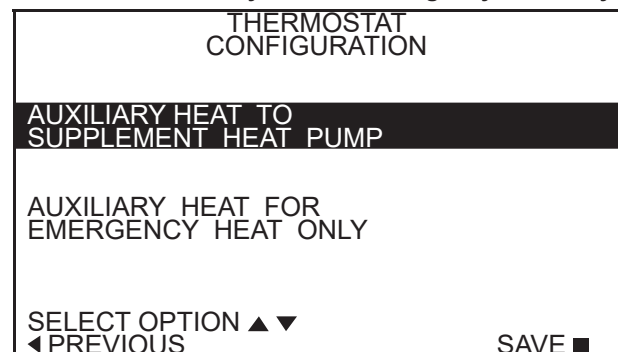

### 3.0 System Configuration

Use the System Configuration option on the start-up screen to adjust critical equipment settings.

The System Configuration information will be automatically obtained from each communicating control in the system.

**Note 1:** The Airflow Selection menu (section 3.1) will not be present if the connected communicating control system has no blower.

**Note 2:** The Pump Configuration menu (section 3.4) will not be present if the connected communicating control is configured for No Loop Configuration (OTHER).

**Note 3:** The Valve Configuration menu (section 3.5) will not be present if the connected communicating control is configured for No Loop Configuration (OTHER).

INSTALLER SETTINGS	
THERMOSTAT CONFIG	
<b>SYSTEM CONFIG</b>	
ACCESSORY CONFIG	
INPUT DEALER INFO	
HUMIDITY CONFIG	
TEMPERATURE CONTROL	
DEMAND REDUCTION CNFG	
SERVICE MODE	
SETPOINT LIMITS	
RESTORE DEFAULTS	
DXM2	3.3
7602-457	C 1.0
SELECT OPTION ▲ ▼	
◀ PREVIOUS	

SYSTEM CONFIGURATION	
AIRFLOW SELECTION	
OPTION SELECTION	
UNIT CONFIG	TE026
PUMP CONFIGURATION	
SELECT OPTION ▲ ▼	
◀ PREVIOUS	
	SAVE ■

#### 3.1 AIRFLOW SELECTION

Adjust the airflow settings for each system operating mode using the up/down arrow buttons. Press the center button to select each item.

- **Airflow Settings (defaults stored in control)**  
- valid range: obtained from control (in 25 CFM increments)
- **Blower Off Delay (default 60 seconds)** – valid range: 0 to 255 seconds (in 5 second increments)

**NOTE 1:** The Airflow Settings will only be present if the connected communicating control is configured for ECM blower.

**NOTE 2:** If multiple units are connected to one thermostat, refer to section 3.6 for unit selection.

AIRFLOW SELECTION	
	CFM
HEAT STAGE 1	600
HEAT STAGE 2	750
AUXILIARY HEAT	850
EMERGENCY HEAT	850
COOL STAGE 1	525
COOL STAGE 2	700
COOL DEHUMID 1	425
COOL DEHUMID 2	550
CONTINUOUS FAN	350
HEAT OFF DELAY	60
COOL OFF DELAY	30
◀ PREVIOUS	NEXT ▶

#### 3.2 OPTION SELECTION

This option allows the configuration of heat pump options to be modified.

Adjust the Option settings using the up/down arrow buttons. Press the center button to select each item.

- **Motorized Valve (defaults stored in control)** – valid range: Off, On “On” delays compressor start until the valve is fully open.

**NOTE:** “Motorized Valve” used here refers to a two-position motorized water valve, not to be confused with the modulating motorized water valve found in the LOOP CONFIG.

- **Compressor ASCD (Anti-Short Cycle Delay (default stored in control))** – valid range: 5 to 8 (in 1 minute increments)

**NOTE 1:** The Compressor Anti-Short Cycle Delay setting provides equipment protection by forcing the compressor to wait a few minutes before restarting.

**NOTE 2:** If multiple units are connected to one thermostat, refer to section 3.6 for unit selection.



**⚠ CAUTION! ⚠**

**CAUTION!** This is a Commercial option only and does not alter Residential unit operation.

OPTION SELECTION	
MOTORIZED VALVE	OFF
COMPRESSOR ASCD	5
◀ PREVIOUS	NEXT ▶

### 3.3 UNIT CONFIGURATION

Adjust the Unit Configuration settings including Heat Pump Family, Heat Pump Size, Blower Type, and Loop Configuration using the up/down arrow buttons. Press the center button to select each item.

- **Heat Pump Family (default stored in control)** – valid range: TE, TY, TES, TEP, TRT, TSM
- **Heat Pump Size (default stored in control)** – valid range: depends on Heat Pump Family setting
- **Blower Type (default stored in control)** – valid range: NO BLOWER, 2-SPD PSC, COM ECM-V, 1-SPD PSC, 2-SPD CTM, PWM ECM, VFD
- **Loop Config (default stored in control)** – valid range: Other, VS PUMP, MOD VALVE

Airflow, pump and valves can be configured from 'System Configuration' screen.

Select 'VS PUMP' when applying an internal variable speed flow controller with other flow controllers on a single loop in parallel.

**NOTE:** Refer to section 3.6.3 for multi-unit configuration instructions.

UNIT CONFIGURATION	
CURRENT CONFIG	TE026
HEAT PUMP FAMILY	TE
HEAT PUMP SIZE	026
BLOWER TYPE	ECM
LOOP CONFIG	VS PUMP
SELECT OPTION ▲ ▼	SAVE ■
◀ PREVIOUS	

### 3.4 PUMP CONFIGURATION

vFlow™ vs internal flow control pump can be controlled either through temperature differential (Delta T) or can be set to specific speed (fixed; % of full speed for each heat and cool stage).

Can be configured for either single pumping or parallel pumping.

Configure temperature differentials at the thermostat for vFlow™ units with an internal flow control pump.

Adjust the Pump Configuration settings using the up/down arrow buttons. Press the center button to select each item.

- **Heating Delta T (default stored in control)** – valid range: 4 to 12°F (in 1°F increments)
- **Cooling Delta T (default stored in control)** – valid range: 9 to 20°F (in 1°F increments)

Maximum Heat LWT (valid range based on specific model; refer to model IOM). Minimum Cool LWT (valid range based on specific model; refer to model IOM).

**NOTE:** Refer to section 3.6.3 for multi-unit configuration instructions.

VARIABLE SPD INTERNAL PUMP CONFIGURATION	
LOOP OPTION	PARALLEL
PUMP CONTROL	DELTA T
HEATING DELTA T	7 F
COOLING DELTA T	10 F
MAXIMUM HEAT LWT	80 F
MINIMUM COOL LWT	40 F
◀ PREVIOUS	SELECT ■

To control vs pump by fixed speed, select 'Pump Control', press ■, use down arrow to select 'Fixed', and press ■ to save.

Default stored in control. Valid range: 15% - 90% (in 1% increments)

Heating Stage 1                      Cooling Stage 1  
 Heating Stage 2                      Cooling Stage 2

If Loop Option is set to 'PARALLEL', valid range changes to 50-90% (in 1% increments).

Equivalent Model Numbers	
Heat Controller	Climate Master
HE-Series	TZ
HZ-Series	TE
HZS-Series	TES
HB-Series 0.5-5T	TC
HB-Series 7-25T	TL
HKV-Series	TL
HRC-Series	TRC



VARIABLE SPD INTERNAL PUMP CONFIGURATION	
LOOP OPTION	SINGLE
PUMP CONTROL	FIXED
HEATING STAGE 1	60%
COOLING STAGE 2	75%
COOLING STAGE 1	50%
COOLING STAGE 2	70%
◀ PREVIOUS	SELECT ▶

### 3.5 VALVE CONFIGURATION

Configure temperature differentials at the thermostat for vFlow™ units with a motorized modulating valve.

Adjust the Valve Configuration settings using the up/down arrow buttons. Press the center button to select each item.

- **Heating Delta T (default stored in control)** – valid range: 4 to 12°F (in 1°F increments)
- **Cooling Delta T (default stored in control)** – valid range: 9 to 20°F (in 1°F increments)

**NOTE 1:** Minimum and Maximum degree values are shown only when the control is configured with the appropriate values.

**NOTE 2:** Refer to section 3.6.3 for multi-unit configuration instructions

MODULATING VALVE CONFIGURATION	
OFF POSITION	0.0
VALVE CONTROL DELTA T	
HEATING DELTA T	7 F
COOLING DELTA T	10 F
MAXIMUM HEAT LWT	80 F
MINIMUM COOL LWT	40 F
◀ PREVIOUS	SELECT ▶

For certain commercial multi-unit applications, the modulating valve can be kept slightly open by choosing an off position value between 3.3-4.0.

**NOTE:** Off position 0.0 means that the value is fully closed when the unit is not operating.

### 3.6 MULTI-UNIT CONFIGURATION

If multiple units are connected to one ATC thermostat upon unit start-up, the thermostat will automatically register the serial numbers of all units connected to it.

**NOTE:** Multiple units may be connected directly to the ATC thermostat or connected to one another in series, as shown by the figure below.



Or

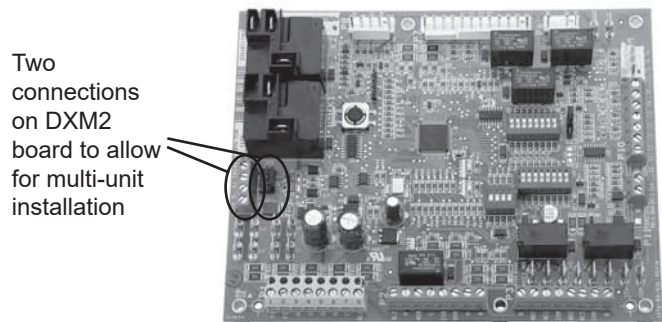

### 3.6.1 MULTI-UNIT AIRFLOW SELECTION

In section 3.1, when an installer selects "Airflow Selection" from the System Configuration menu, the installer may choose the unit to configure by the last 4 digits of its serial number from the following screen.

AIRFLOW SELECTION	
TT026	S N ----- 1 2 3 4
TT026	S N ----- 5 6 7 8
TT038	S N ----- 9 0 1 2
◀ PREVIOUS	SELECT ▶

### 3.6.2 MULTI-UNIT OPTION SELECTION

In section 3.2, when an installer selects “Option Selection” from the System Configuration menu, the installer may choose the unit to configure by the last 4 digits of its serial number from the following screen.

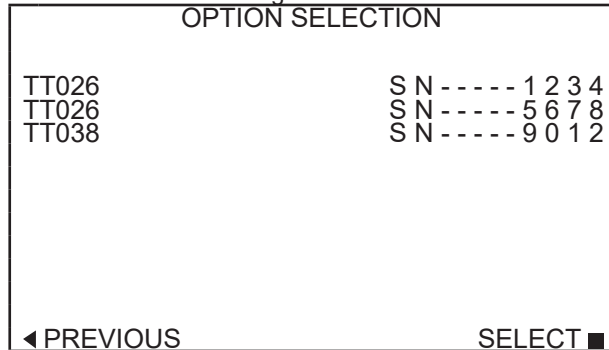

### 3.6.3 Multi-Unit, Unit, Pump, & Valve Configuration

To configure Unit, Pump, and Valve options in sections 3.3-3.5, the thermostat must be connected to only one unit at a time.

## 4.0 Accessory Configuration

A service message will flash at the top of the Main screen when a service timer expires to alert the user that it is time to service these options. Refer to DXM2 AOM for instructions on configuring DIP switches to configure accessories. Follow the instructions below to set service timers.

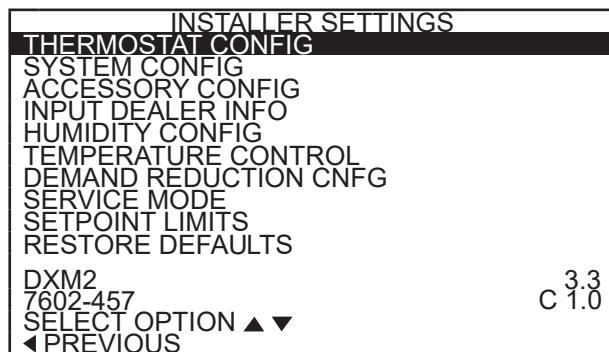

### 4.1 AIR FILTER

This feature displays an alert to remind the user to change the air filter after the selected time has passed.

Adjust the Air Filter Reminder settings using the up/down arrow buttons. Press the center button to save changes.

- **Cumulative Run Time (default Off)** – valid range: Off, 400 to 3600 hours (in 100 hour increments)
- **Calendar Time (default Off)** – valid range: Off, 3 to 48 months (in 3 month increments)

### 4.2 HUMIDIFIER

This feature displays an alert to remind the user to change the humidifier pad after the selected time has passed.

Adjust the Humidifier Reminder settings using the up/down arrow buttons. Press the center button to save changes.

- **Cumulative Run Time (default Off)** – valid range: Off, 400 to 3600 hours (in 100 hour increments)
- **Calendar Time (default Off)** – valid range: Off, 3 to 24 months (in 3 month increments)

### 4.3 UV LAMP

This feature displays an alert to remind the user to change the UV lamps after the selected time has passed.

Adjust the UV Lamp Reminder settings using the up/down arrow buttons. Press the center button to save changes.

- **Cumulative Run Time (default Off)** – valid range: Off, 400 to 3600 hours (in 100 hour increments)
- **Calendar Time (default Off)** – valid range: Off, 3 to 48 months (in 3 month increments)

### 4.4 AIR CLEANER

This feature displays an alert to remind the user to clean the filter(s) after the selected time has passed.

Adjust the Air Cleaner Reminder settings using the up/down arrow buttons. Press the center button to save changes.

- **Cumulative Run Time (default Off)** – valid range: Off, 400 to 3600 hours (in 100 hour increments)
- **Calendar Time (default Off)** – valid range: Off, 3 to 24 months (in 3 month increments)

## 5.0 Input Dealer Information

Enter/edit the Dealer Information settings, including Brand Name, Model Number, Serial Number, Contractor Name, and Contractor Phone number, using the up/down arrow buttons. Press the center button to save changes.

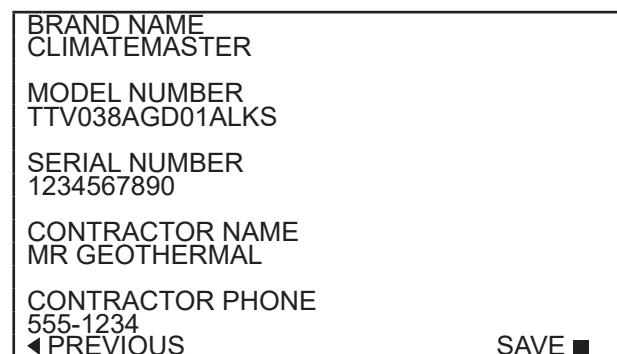

## 6.0 Humidity Configuration

Configure humidity control settings (dehumidification/humidification).

Adjust the Humidity Control settings using the up/down arrow buttons. Press the center button to save changes.

- **Dehumidification** – This logic will communicate a Dehumidification output when the humidity is greater than the setpoint (acts as a dehumidistat). The Dehumidification output will not be communicated when the humidity is below the setpoint.
- **Humidification** – This logic will communicate a Humidification output when the humidity is less than the setpoint (acts as a humidistat). When the Humidification output is active, the fan output will also be active. The Humidification output will not be communicated when the humidity is above the setpoint.
- **Both** – Incorporates both Dehumidification and Humidification logic.
- **None (default)** – Dehumidification and Humidification outputs will not be communicated.

## 7.0 Temperature Algorithm

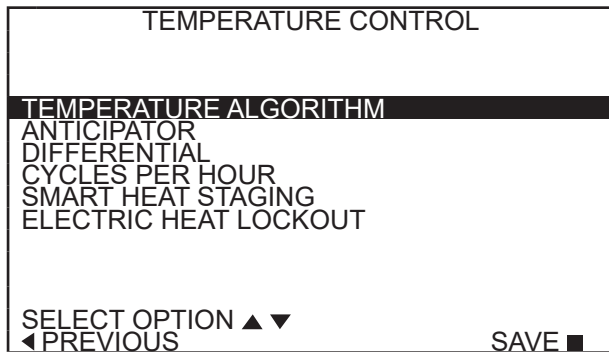

### 7.1 TEMPERATURE CONTROL

Configure the logic the thermostat uses to meet the temperature setpoints.

- **Proportional Integral (default)** – This logic will use a combination of temperature differential and operating time to determine the appropriate heating or cooling stages for operation (see NOTE 1).
- **Proportional Integral (No Down Staging)** – This logic includes the Proportional Integral logic, but in addition the logic keeps all active heating or cooling stages energized until the demand is fully satisfied (see NOTE 1).
- **Differential** – This logic will only use temperature differential to determine the appropriate heating or cooling stages for operation. This logic will keep all active heating or cooling stages energized until the demand is fully satisfied (see NOTE 2).

**NOTE 1:** The Proportional Integral options require first stage heating or cooling to be active for a minimum of 5 minutes, before energizing second stage when configured for multi stage operation.

**NOTE 2:** The Differential option will activate first stage heating or cooling when the temperature is more than the first stage differential value (User Manual section 5.6.2.3), below or above the setpoint. Second stage heating or cooling will be activated when the temperature is more than the first and second stage differential values combined (User Manual section 5.6.2.3), below or above the setpoint. Third stage heating will be activated when the temperature is more than the first, second, and third stage differential values combined (User Manual section 5.6.2.3), below the setpoint.

### 7.2 ANTICIPATOR

If you find that the thermostat is overshooting or undershooting the temperature setpoint value, the Anticipator setting allows for adjustment to correct the temperature algorithm. When the Anticipator value is set to a lower number, the thermostat becomes more sensitive and when the Anticipator value is raised, the thermostat becomes less sensitive. If the thermostat is overshooting the temperature setpoint, adjust the Anticipator value up to reduce thermostat sensitivity. If the thermostat is undershooting the temperature setpoint, adjust the Anticipator value down to increase thermostat sensitivity.

Adjust the Anticipator setting using the up/down arrow buttons. Press the center button to save changes.

- **Anticipator (default 3): valid range: 1 to 9**

### 7.3 DIFFERENTIAL

The Differential adjustment will vary the number of degrees from the setpoint before a call for heating or cooling is made. Use this function if you find that the thermostat is starting a call too soon/late or staging equipment up/down too quickly/slowly. For example, with a 1 °F 1st stage differential and a heating setpoint of 70°F, your thermostat will not call for heating until the temperature is 69°F.

Adjust the Differential setting using the up/down arrow buttons. Navigate between Differentials using the left/right arrow buttons. Press the center button to save changes.

### 7.4 CYCLES PER HOUR

The thermostat allows the user to adjust the maximum number of on/off cycles per hour to maintain the desired indoor temperature.

Adjust the Cycles per Hour setting using the up/down arrow buttons. Press the center button to save changes.

- **4 (default):** operation will start no sooner than 15 minutes after the previous call was initiated
- **6:** operation will start no sooner than 10 minutes after the previous call was initiated (can provide tighter temperature control)

### 7.5 SMART HEAT STAGING

When there is auxiliary heating demand, Smart Heat Staging defines the minimum amount of time to wait before activating auxiliary heating. If you find that the thermostat is operating auxiliary heating equipment too quickly/slowly, this setting allows for adjustment to correct the temperature algorithm.

Adjust the Smart Heat Staging setting using the up/down arrow buttons. Press the center button to save changes.

- **Smart Heat Staging (default Off):** options: OFF, 5 – 120 minutes (in 5 minute increments)

### 7.6 ELECTRIC HEAT LOCKOUT

Electric heat lockout keeps electric heat turned off if the outdoor temperature is above the specified temperature so as only to use electric heat when necessary.

Adjust the Electric Heat Lockout setting using the up/down arrow buttons. Press the center button to save changes.

- **Electric Heat Lockout (default Off):** options: OFF, 5 – 60°F (in 5°F increments)

**NOTE:** An outdoor temperature sensor must be installed for this feature to work.

## 8.0 Demand Reduction Configuration

Demand Reduction is activated by an input signal at the unit control board to reduce the electric load while peak utility rates are high. The Demand Reduction Configuration mode selects which of the available unit control inputs is to be used as the activation signal. While a physical input signal is present at the selected input, the thermostat will implement load reduction by limiting operation or capacity. Refer to section 5.6.9 in the user manual (part number 97B0055N02) for more details on Demand Reduction.

Adjust the Demand Reduction Configuration setting using the up/down arrow buttons. Press the center button to save changes.

- **No Demand Reduction (default)** – Demand Reduction operating mode will not be activated by a DXM2 input.
- **DXM2 Inputs** – Assigns a DXM2 input to activate Demand Reduction operating mode.

INSTALLER SETTINGS	
THERMOSTAT CONFIG	
SYSTEM CONFIG	
ACCESSORY CONFIG	
INPUT DEALER INFO	
HUMIDITY CONFIG	
TEMPERATURE CONTROL	
<b>DEMAND REDUCTION CNFG</b>	
SERVICE MODE	
SETPOINT LIMITS	
RESTORE DEFAULTS	
DXM2	3.3
7602-457	C 1.0
SELECT OPTION ▲ ▼	
◀ PREVIOUS	

## 9.0 Service Mode

SERVICE MODE	
MANUAL OPERATION	
CONTROL DIAGNOSTICS	
DIPSWITCH CONFIG	
FAULT HISTORY	
CLEAR FAULT HISTORY	
SELECT OPTION ▲ ▼	
◀ PREVIOUS	SELECT ■

### 9.1 MANUAL OPERATION

Manual Operation mode allows the service personnel to manually command operation for any of the thermostat outputs, blower speed, as well as pump speed or valve position to help troubleshoot specific components.

**NOTE 1:** The ECM Airflow adjustment will not be present if the connected communicating control (DXM2) is not configured for ECM (section 3.3).

**NOTE 2:** The Pump Speed adjustment will not be present if the connected communicating control (DXM2) is not configured for Pump (section 3.3).

**NOTE 3:** The Valve Position adjustment will not be present if the connected communicating control (DXM2) is configured for Valve (section 3.1).

**NOTE 4:** If multiple units are connected to one thermostat, refer to section 9.6

MANUAL OPERATING MODE			
Y1	COMM	OUTPUT	OFF
Y2	COMM	OUTPUT	OFF
W	COMM	OUTPUT	OFF
O	COMM	OUTPUT	OFF
G	COMM	OUTPUT	OFF
H	COMM	OUTPUT	OFF
DH	COMM	OUTPUT	OFF
ECM	AIRFLOW		0
PUMP	SPEED		0%
TEST	MODE		OFF
SELECT OPTION ▲ ▼			
◀ PREVIOUS			SELECT ■

### 9.2 CONTROL DIAGNOSTICS

Control Diagnostics mode allows the service personnel to view the status of all physical inputs, switches, temperature sensor readings, as well as the operational status of the pump at the thermostat.

Navigate between diagnostic screens using the left/right arrow buttons.

**NOTE 1:** The Pump Status will not be present if the connected communicating control (DXM2) is not configured for Pump (section 3.3).

**NOTE 2:** If multiple units are connected to one thermostat, refer to section 9.6.

CONTROL DIAGNOSTICS - 1	
LT1 TEMP	38.1
LT2 TEMP	79.9
COMP DISCHARGE	157.7
ENTERING WATER	78.5
LEAVING WATER	73.3
HOT WATER EWT	121.5
LEAVING AIR	75.1
LOOP PUMP SPD	60%
LOOP PUMP WATTS	140
LOOP FLOW GPM	7.4
ECM BLOWER RPM	550
ECM TARGET CFM	800
ECM BLOWER STATIC	0.5
◀ PREVIOUS	NEXT ▶

CONTROL DIAGNOSTICS - 2	
HP SWITCH	CL
LOC SWITCH	CL
Y1 PHYSICAL INPUT	ON
Y2 PHYSICAL INPUT	OFF
W PHYSICAL INPUT	OFF
O PHYSICAL INPUT	ON
G PHYSICAL INPUT	ON
H PHYSICAL INPUT	OFF
EMERG SHUTDOWN	OFF
NIGHT SETBACK	OFF
OVR INPUT	OFF
CONTROL VOLTAGE	26.4
◀ PREVIOUS	

**9.3 DIPSWITCH CONFIGURATION**

Dipswitch Configuration mode allows the service personnel to view the status of all dipswitch settings for the connected communicating control (DXM2/AXM) at the thermostat.

Navigate between configuration screens using the left/right arrow buttons.

**NOTE 1:** The unit control dipswitch settings cannot be changed from the thermostat.

**NOTE 2:** If multiple units are connected to one thermostat, refer to section 9.6.

CONTROL CONFIGURATION DIPSWITCH S1	
1	ON UPS ENABLED
2	ON DUAL COMP STG 1
3	ON HEAT PUMP TSTAT
4	ON RV O THERMOSTAT
5	ON DEHUMID OFF
6	ON EH2 AUX HEAT
7	ON BOILERLESS
8	ON SEE DXM2 AOM
◀ PREVIOUS	NEXT ▶

CONTROL CONFIGURATION DIPSWITCH S2	
1	ON \ ACCESSORY 1
2	ON ACCESSORY 2
3	ON /
4	ON \ ACCESSORY 2
5	ON ACTIVE W/ COMP
6	ON /
7	ON H DEHUM INPUT
8	ON FACTORY SETTING
◀ PREVIOUS	NEXT ▶

CONTROL CONFIGURATION DIPSWITCH S3	
1	ON FACTORY SETTING
2	OFF HWG TEST OFF
3	OFF HWG SP 125
4	OFF HWG DISABLED
JW3 LT1 SETTING WELL	
◀ PREVIOUS	

**9.4 FAULT HISTORY**

Fault History mode displays the five most recent stored fault codes for the connected communicating control (DXM2).

Navigate between control fault codes using the up/down arrow buttons. Press the center button to view more information about the highlighted fault code.

**NOTE:** If multiple units are connected to one thermostat, refer to section 9.7.

TT038 SN - - - - - 0 1 2 3 LAST 5 FAULTS	
LT1	LOW WATER TEMP
NO	FAULT
NO	FAULT
NO	FAULT
NO	FAULT
◀ PREVIOUS	NEXT ▶ SELECT ■



FAULT CONDITION MENU	
LT1 LOW WATER TEMP HEAT 1 11:11 AM 11/14	
<b>FAULT TEMP CONDITIONS</b>	
FAULT FLOW CONDITIONS	
FAULT I/O CONDITIONS	
FAULT CONFIG COND	
FAULT POSSIBLE CAUSES	
◀ PREVIOUS	SELECT ■

**9.4.1 Temperature Conditions**

Displays detailed temperature readings that were recorded at the time the fault occurred.

**NOTE:** If multiple units are connected to one thermostat, refer to section 9.6.

FAULT TEMPERATURE CONDITIONS	
LT1 LOW WATER TEMP HEAT 1 11:11 AM 11/14	
LT1 TEMP	28.1
LT2 TEMP	97.3
HOT WATER EWT	121.5
COMP DISCHARGE	157.7
LEAVING AIR	92.7
LEAVING WATER	34.9
ENTERING WATER	42.1
CONTROL VOLTAGE	26.4
◀ PREVIOUS	

**9.4.2 Flow Conditions**

Displays detailed blower and pump speed / valve position readings that were recorded at the time the fault occurred.

**NOTE:** If multiple units are connected to one thermostat, refer to section 9.7.

FAULT FLOW CONDITIONS	
LT1 LOW WATER TEMP HEAT 1 11:11 AM 11/14	
ECM TARGET CFM	800
ECM BLOWER RPM	550
FLOW RATE GPM	6.5
PUMP SPEED	60%
PUMP WATTS	140
LOOP CONFIG	VS PUMP
◀ PREVIOUS	SINGLE

**9.4.3 Input/Output Conditions**

Displays the status of all physical and communicated inputs, switches, and control outputs that were recorded at the time the fault occurred.

**NOTE:** If multiple units are connected to one thermostat, refer to section 9.7.

FAULT I/O CONDITIONS			
LT1 LOW WATER TEMP HEAT 1 11:11 AM 11/14			
TSTAT	SAFETY	OUTPT	
CONV	COMM	HPS	CC
Y1	Y1	LOC	RV
Y2	Y2	CO	ACC1
W	W		ACC2
O	O	OUTPT	AL1
G	G	FAN	EH1
H	H	HWG	EH2
OVR	DH	PUMP	
◀ PREVIOUS			

**9.4.4 Configuration Conditions**

Displays the status of all dipswitch settings that were recorded at the time the fault occurred.

**NOTE:** If multiple units are connected to one thermostat, refer to section 9.7.

FAULT CFG CONDITIONS					
LT1 LOW WATER TEMP HEAT 1 11:11 AM 11/14					
	S1	S2	S3		
1	ON	1 ON	1 ON		
2	ON	2 ON	2 OFF		
3	ON	3 ON	3 OFF		
4	ON	4 ON	4 OFF		
5	ON	5 ON		LT1 WELL	
6	ON	6 ON		LT2 WELL	
7	ON	7 ON			
8	ON	8 ON			
◀ PREVIOUS					

**9.4.5 Possible Causes**

Possible causes as to why the fault occurred

**NOTE:** If multiple units are connected to one thermostat, refer to section 9.7.

POSSIBLE FAULT CAUSES	
LOW WATER COIL TEMP	
LOW WATER TEMP - HTG	
LOW WATER FLOW - HTG	
LOW REFRIG CHARGE - HTG	
INCORRECT LT1 SETTING	
BAD LT1 THERMISTOR	
◀ PREVIOUS	

**9.5 CLEAR FAULT HISTORY**

Clear Fault History will clear all fault codes stored in the thermostat as well as the fault history in any connected communicating controls (DXM2/AXM).

**9.6 MULT-UNIT DIAGNOSTICS**

If multiple units are connected to one thermostat when Manual Operation, Control Diagnostics, or Dip Switch Configuration is selected, the service personnel will see a screen to select a specific unit by the last 4 digits of its serial number.

**NOTE:** Multiple units may be connected directly to the ATC thermostat or connected to one another in series, as shown by the figure below.



Or



Two connections on DXM2 board to allow for multi-unit installation

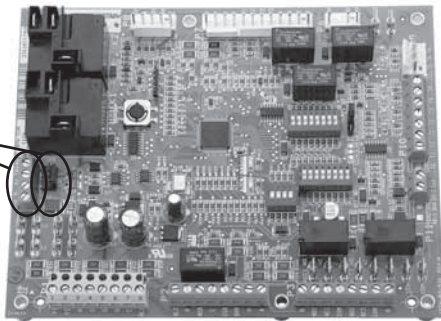

**9.7 MULT-UNIT FAULT INFO**

When multiple units are connected to one thermostat, UNLIKE Multi-Unit Diagnostics, the service personnel views each units' fault information by selecting the next option.

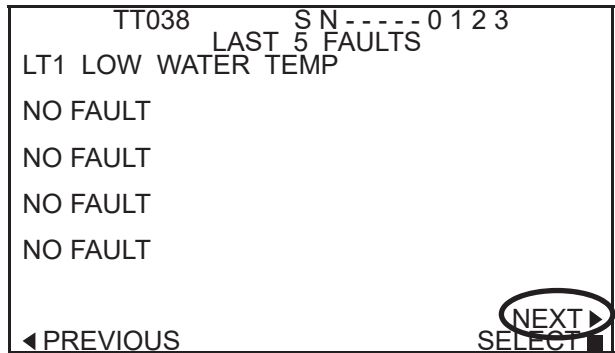

**10.0 Restore Defaults**

The thermostat will reset all settings, excluding the thermostat configuration settings (section 2), to their factory defaults.

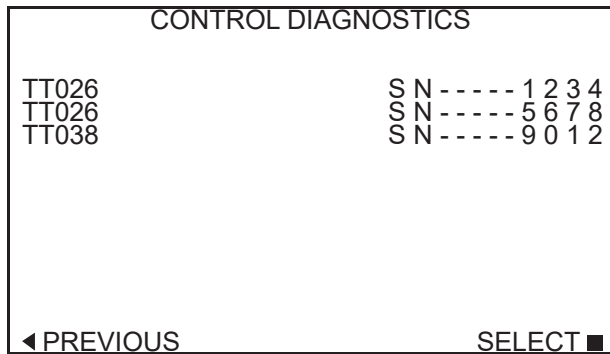



Due to ongoing product improvements, specifications and dimensions are subject to change and correction without notice or incurring obligations. Determining the application and suitability for use of any product is the responsibility of the installer. Additionally, the installer is responsible for verifying dimensional data on the actual product prior to beginning any installation preparations.

Incentive and rebate programs have precise requirements as to product performance and certification. All products meet applicable regulations in effect on date of manufacture; however, certifications are not necessarily granted for the life of a product. Therefore, it is the responsibility of the applicant to determine whether a specific model qualifies for these incentive/rebate programs.



1900 Wellworth Ave., Jackson, MI 49203 • Ph. 517-787-2100 • [www.marsdelivers.com](http://www.marsdelivers.com)

