

---

*Comfort-Cire*®

**Century**®

---

**Submittal Data**

**HZH/V Series**

**MARS**®  
Delivering Confidence

---

[www.marsdelivers.com](http://www.marsdelivers.com)

# HZ Premier Efficiency Series

Unit Features	4
iGate® Communicating Controls	6
vFlow® Internal Variable Water Flow Control	7
Selection Procedure	8
HZ Series Nomenclature	10
Performance Data AHRI/ASHRAE/ISO 13256-1	11
Performance Data Selection Notes - vFlow™ Models	12
Performance Data – HZ H/V/D 024 (Part Load), No vFlow®	13
Performance Data – HZ H/V/D 024 (Part Load), No vFlow®	14
Performance Data – HZ H/V/D 036 (Part Load), No vFlow®	15
Performance Data – HZ H/V/D 036 (Full Load), No vFlow®	16
Performance Data – HZ H/V/D 048 (Part Load), No vFlow®	17
Performance Data – HZ H/V/D 048 (Full Load), No vFlow®	18
Performance Data – HZ H/V/D 060 (Part Load), No vFlow®	19
Performance Data – HZ H/V/D 060 (Full Load), No vFlow®	20
Performance Data – HZ H/V/D 070 (Part Load), No vFlow®	21
Performance Data – HZ H/V/D 070 (Full Load), No vFlow®	22
Performance Data – HZ H/V/D 024 (Part Load), With vFlow®	23
Performance Data – HZ H/V/D 024 (Full Load), With vFlow®	24
Performance Data – HZ H/V/D 036 (Part Load), With vFlow®	25
Performance Data – HZ H/V/D 036 (Full Load), With vFlow®	26
Performance Data – HZ H/V/D 048 (Part Load), With vFlow®	27
Performance Data – HZ H/V/D 048 (Full Load), With vFlow®	28
Performance Data – HZ H/V/D 060 (Part Load), With vFlow®	29
Performance Data – HZ H/V/D 060 (Full Load), With vFlow®	30
Performance Data – HZ H/V/D 070 (Part Load), With vFlow®	31
Performance Data – HZ H/V/D 070 (Full Load), With vFlow®	32
Part Load Performance Data – Correction Tables	33
Full Load Performance Data – Correction Tables	34
Antifreeze & Water Pressure Drop Adder for Options – Correction Tables	35
Variable Pump Performance	36
ECM Blower Control	37
Blower Performance Data	38
ClimaDry II - Benefits and Application	39
ClimaDry II - Sequence of Operation	41
Physical Data	43

# HZ Premier Efficiency Series

HZ - Horizontal Dimensional Data	44
HZ - Horizontal Service Access	46
HZ - Vertical Upflow Dimensional Data	47
HZ - Vertical Service Access	49
HZ - Vertical Downflow Dimensional Data	50
Corner Weights	52
Electrical Data	53
HZ Series Wiring Diagram Matrix	55
Typical Wiring Diagram – Single Phase HZ Units with Modulating Water Valve	56
Typical Wiring Diagram – Single Phase 208/230V HZ Units with Variable Pump	57
Typical Wiring Diagram – Single Phase HZ Units with MWV and MPC Controller	58
Typical Wiring Diagram – Single Phase HZ Units with MWV and LON Controller	59
Engineering Specifications	60
Performance Table	69
Revision History	71



## Unit Features

### THE HZ SERIES

As one of the highest efficiency water-source heat pump on the planet, the HZ Series raises the bar for water-source heat pump efficiencies, features and application flexibility. Not only does the HZ Series far exceed ASHRAE 90.1 efficiencies, but it also uses EarthPure® (HFC-410A) zero ozone depletion refrigerant, making it an extremely environmentally-friendly option. HZ is eligible for additional LEED® (Leadership in Energy and Environmental Design) points because of its “green” technology design.

Available in sizes 2 tons (7.0 kW) through 6 tons (19.3 kW) with multiple cabinet options (vertical upflow, vertical downflow and horizontal) the units offer a wide range of units for most any installation. The HZ has an extended range refrigerant circuit, capable of ground loop (geothermal) applications as well as water loop (boiler-tower) applications. Standard features are many. Copeland UltraTech™ two-stage unloading scroll compressor, ECM variable communicating fan motor, communicating microprocessor controls, galvanized steel cabinet, polyester powder coat paint, stainless steel drain pan and foil-backed air handler insulation are just some of the features of the innovative HZ Series.

Comfort-Aire/Century's exclusive double isolation compressor mounting system makes the HZ one of the quietest units on the market. Compressors are mounted on specially engineered sound tested EPDM grommets to a heavy gauge mounting plate, which is then isolated from the cabinet base with rubber grommets for maximized vibration/sound attenuation. User friendly installation and maintenance are provided by the multiple removable access panels and easy access control box. Options such as DDC controls, internal variable speed pumps, modulating water valves, and high efficiency MERV rated air filters allow customized design solutions.

iGate® technology is the next generation in intelligent control by using two-way communication to provide a gateway into the system. The iGate® control system allows end-users and contractors to monitor the performance of the unit, custom tailor its operation, and diagnose any issues, right from the thermostat.

The iGate® communications hub is the DXM2 intelligent controller, which analyzes the status of sensors and smart components (which are also two-way communicating) to determine how best to operate the system for optimal comfort, efficiency and long-term reliability. All of this information is passed to the iGate® thermostat (or diagnostic tool), where it can be displayed in plain English. And since communication is both ways, the iGate® thermostat can also be used to configure and tailor the system without even touching the unit.

vFlow® variable water flow technology represents a major advance in geothermal system performance made possible through the iGate® system. vFlow® not only builds the major water circulation components into the unit for a clean installation, it also intelligently varies the water flow to minimize pump energy consumption and improve system reliability.

The heart of vFlow® is either a variable-speed pump (for ground loops) or modulating water valve (for ground water or central variable speed pumps) directly linked into the iGate® system. Water flow is automatically varied based on changes in unit capacity level (stage) and source water temperature to maintain optimum system performance. vFlow® allows the use of direct return piping, while eliminating external two-ways valves and automatic flow regulators. vFlow® systems are inherently self-balancing.

vFlow® systems provide reduced water pumping power compared to traditional fixed-speed pumping and protects the unit against extreme operating conditions, extending the life of the compressor and air coil. Since vFlow® is built inside the unit, it also saves on installation time and makes for a very clean and compact installation. The HZ Series water-source heat pumps are designed to meet the challenges of today's HVAC demands with one of the most innovative products available on the market.

## Unit Features

### UNIT FEATURES

- Sizes 024 (2 ton, 7.0 kW) through 070 (6 tons, 19.3 kW)
- EarthPure® (HFC-410A) refrigerant
- Copeland UltraTech™ two-stage unloading scroll compressors
- ECM variable speed communicating fan motor with soft start
- Exceeds ASHRAE 90.1 efficiencies
- Part load operation significantly lowers annual operating costs
- Galvanized steel construction with attractive black mat polyester powder coat paint and silver accents
- Stainless steel drain pan
- Foil-backed insulation in air handler section
- Unique double isolation compressor mounting with vibration isolation for quiet operation
- Insulated divider and separate compressor/air handler compartments
- TXV metering device
- Extended range (20 to 120°F, -6.7 to 48.9°C) operation
- **Advanced Controls** - iGate® communicating control provides advanced unit functionality and comprehensive configuration, monitoring and diagnostic capabilities through digital communication links with the variable-speed fan motor, variable-speed source pump (or modulating valve) and communicating thermostat or Configuration/Diagnostic tool.
  - 7 temperature sensor inputs for system protection and control
  - Anti-short cycle and over/under voltage protection
  - High pressure, loss of charge, and condensate overflow protection
  - LED fault and status indication at controller
  - Service tool port for optional setup and diagnostics at unit
- LonWorks, BACnet, Modbus and Johnson N2 compatibility options for DDC controls
- Field convertible discharge air arrangement for horizontal units
- Easy access control box
- Flush securely-mounted corner post water connections (no backup wrench required)
- Unit Performance Sentinel performance monitoring system
- Eight Safeties Standard
- Wide variety of options including ultra quiet sound insulation, extended range insulation, return air filter frames, variable and fixed speed circulating pumps, modulating motorized valves, hot water generator, and cupro-nickel water coil

# iGate® Communicating Controls

## iGate® Information gateway to monitor, control and diagnose your system

HZ Series is equipped with industry-first, iGate® – Information Gateway – 2-way communicating system that allows users to interact with their geothermal system in plain English AND delivers improved reliability and efficiency by precisely controlling smart variable speed components. iGate® makes Tranquility® Digital series the easiest geothermal products to install and service.

**Monitor/Configure** – Installers can configure HZ units from the iGate® communicating thermostat or configuration/diagnostic tool, including: Air flow, loop, water-flow option configuration, unit configuration, accessory configuration, and demand reduction (optional, to limit unit operation during peak times). Users can look up the current system status: temperature sensor readings and operational status of the blower and pump.

**Precise Control** – The new DXM2 board enables intelligent, 2-way communication between the DXM2 board and smart components like the communicating thermostat, fan motor, and water pump. The DXM2 control can also directly control the modulating valve and accepts various feedback/input (see figure). The Intelligent DXM2 board uses information received from the smart components and sensors to precisely control operation of variable speed fan, variable speed water pump (or modulating valve) to deliver higher efficiency, reliability and increased comfort.

**Diagnostics** – iGate® takes diagnosing geothermal units to a next level of simplicity, by providing a dashboard of system and fault information, in plain English, on the iGate thermostat/ service tool.

iGate® Service Warning warns the occupant of a fault and displays fault description, possible causes and current system status (temperature readings, fan RPM and water flow status) which may be reported to service personnel.

In iGate® Service Mode, the service personnel can access fault description, possible causes and most importantly, the conditions (temp, flow, i/o conditions, configuration) at the time of the fault. Manual Operation mode allows the service personnel to manually command operation for any of the thermostat outputs, blower speed, as well as pump speed or valve position from the thermostat, to help troubleshoot specific components.

With iGate® communicating system, users and contractors have a gateway to system information never before available.

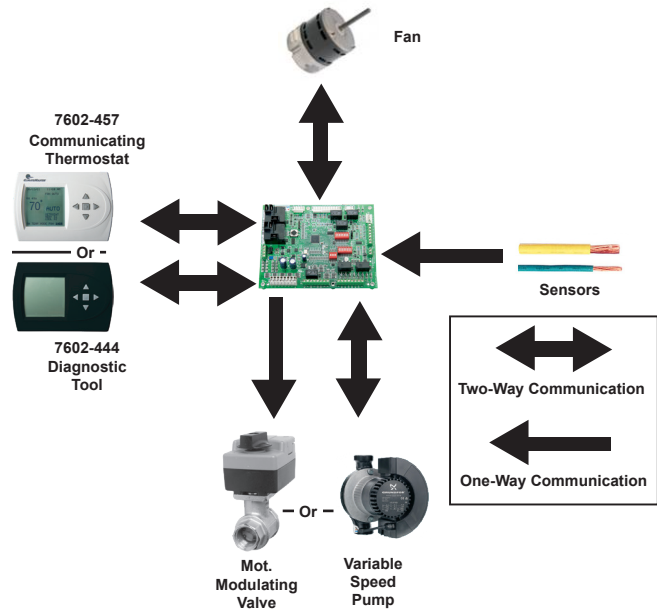

AIRFLOW SELECTION	
HEAT STAGE 1	600
HEAT STAGE 2	750
AUXILIARY HEAT	850
EMERGENCY HEAT	850
COOL STAGE 1	525
COOL STAGE 2	700
COOL DEHUMID 1	425
COOL DEHUMID 2	550
CONTINUOUS FAN	350
HEAT OFF DELAY	60
COOL OFF DELAY	30
◀ PREVIOUS	NEXT ▶

POSSIBLE FAULT CAUSES	
LOW WATER COIL TEMP	
LOW WATER TEMP - HTG	
LOW WATER FLOW - HTG	
LOW REFRIG CHARGE - HTG	
INCORRECT LT1 SETTING	
BAD LT1 THERMISTOR	
◀ PREVIOUS	

FAULT TEMPERATURE CONDITIONS	
LT1 LOW WATER TEMP	
HEAT 1 11:11 AM 11/14	
LT1 TEMP	28.1
LT2 TEMP	97.3
HOT WATER EWT	121.5
COMP DISCHARGE	157.7
LEAVING AIR	92.7
LEAVING WATER	34.9
ENTERING WATER	42.1
CONTROL VOLTAGE	26.4
◀ PREVIOUS	

## vFlow® Internal Variable Water Flow Control

### vFlow® Internal Variable Water Flow

Industry-first, Built-in vFlow® provide an ultra-high-efficient, variable speed, internal water flow system. It saves installers time and labor by avoiding installing bulky external pumps, valves, or flow regulators. Multi-unit installations are also much simpler with vFlow® systems, as the units automatically adjust water flow across the system.

vFlow® is enabled by iGate®, which facilitates intelligent communication between the thermostat, DXM2 control, sensors and internal water pump/valve to make true variable water flow a reality.

### vFlow® is available in four variations:

1. Low System Pressure Drop Modulating Valve – High CV motorized valve for central pumping.
2. High System Pressure Drop Modulating Valve – Motorized valve for higher pressure water system such as water well pumps.
3. Standard Head Variable Pump – multi unit/central pumping.
4. High Head Variable Pump – multi/individual unit pumping.

### vFlow® delivers three main benefits:

1. Easier and quicker unit installation as the flow control is built in to the unit.
2. Superior reliability by varying the water flow to deliver more stable operation.
3. Higher cost savings by varying the flow (and pump watt consumption) to match the unit's mode of operation.

### Internal components

HZ units can be installed more easily and compactly than its predecessors because water-flow components are internal to the unit. It also saves installing contractors labor and time by eliminating the need for an external flow regulator or a bulky external pumping module.

### Variable flow

vFlow® technology enables variable water flow through the unit, with the DXM2 control adjusting the pump speed to maintain an installer-set loop delta T. By controlling the water flow, the system is able to operate at its optimal capacity and efficiency. vFlow® provides a lower flow rate for part load where units typically operate 80% of the time and a higher, more normal flow rate for full load operation.

### Energy Savings with water circulation control

Units with vFlow® deliver higher operating cost savings by varying the water flow to match the unit's operation (ex: lower water flow when unit is in part load operation). Lowering the flow results in lower energy consumption by the water pump (=higher cost savings) in vFlow® units.

In applications using vFlow® with internal variable-speed

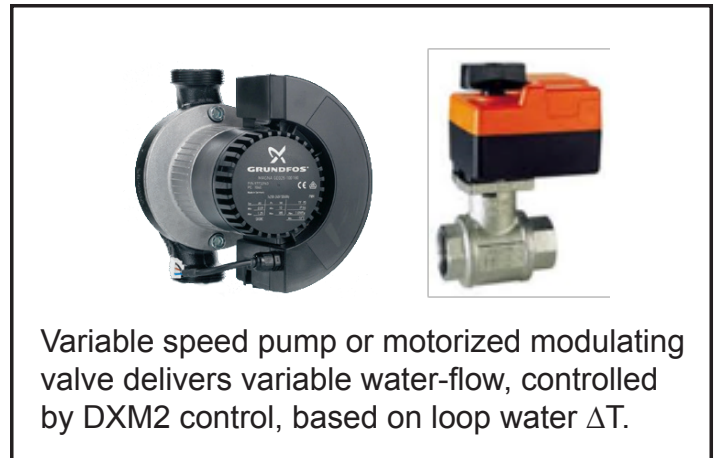

(ECM) pump, the ECM pump uses fewer watts than a fixed speed (PSC) pump, even at full load (see chart). The ECM pump excels in energy savings in part load, saving 70-80% watts compared to fixed speed pumps. The ECM pump can operate with independent flow rates for heating and cooling, further saving more energy.

In applications using vFlow® with modulating valve, when the motorized modulating valve slows down the water flow during part load operation, the external pump consumes fewer watts, thus saving more energy.

# Selection Procedure

## Reference Calculations

Heating	Cooling	
$LWT = EWT - \frac{HE}{GPM \times 500}$	$LWT = EWT + \frac{HR}{GPM \times 500}$	$LC = TC - SC$
$LAT = EAT + \frac{HC}{CFM \times 1.08}$	$LAT (DB) = EAT (DB) - \frac{SC}{CFM \times 1.08}$	$S/T = \frac{SC}{TC}$

## Legend and Glossary of Abbreviations

BTUH = BTU (British Thermal Unit) per hour	HWC = hot water generator (desuperheater) capacity, Mbtuh
CFM = airflow, cubic feet/minute	FPT = female pipe thread
COP = coefficient of performance = BTUH output/BTUH input	KW = total power unit input, kilowatts
DB = dry bulb temperature (°F)	LAT = leaving air temperature, °F
EAT = entering air temperature, Fahrenheit (dry bulb/wet bulb)	LC = latent cooling capacity, BTUH
EER = energy efficiency ratio = BTUH output/Watt input	LWT = leaving water temperature, °F
MPT = male pipe thread	MBTUH = 1000 BTU per hour
ESP = external static pressure (inches w.g.)	S/T = sensible to total cooling ratio
EWT = entering water temperature	SC = sensible cooling capacity, BTUH
GPM = water flow in U.S. gallons/minute	TC = total cooling capacity, BTUH
HE = total heat of extraction, BTUH	WB = wet bulb temperature (°F)
HC = air heating capacity, BTUH	WPD = waterside pressure drop (psi & ft. of hd.)
HR = total heat of rejection, BTUH	

## Conversion Table - to convert inch-pound (English) to S-I (Metric)

Air Flow	Water Flow	Ext Static Pressure	Water Pressure Drop
Airflow (L/s) = CFM x 0.472	Water Flow (L/s) = gpm x 0.0631	ESP (Pa) = ESP (in of wg) x 249	PD (kPa) = PD (ft of hd) x 2.99



## Selection Procedure

- Step 1** Determine the actual heating and cooling loads at the desired dry bulb and wet bulb conditions.
- Step 2** Obtain the following design parameters: Entering water temperature, water flow rate in GPM, air flow in CFM, water flow pressure drop and design wet and dry bulb temperatures. Air flow CFM should be between 300 and 450 CFM per ton. Unit water pressure drop should be kept as close as possible to each other to make water balancing easier. Go to the appropriate tables and find the proper indicated water flow and water temperature.
- Step 3** Select a unit based on total and sensible cooling conditions. Select a unit which is closest to, but no larger than, the actual cooling load.
- Step 4** Enter tables at the design water flow and water temperature. Read the total and sensible cooling capacities (Note: interpolation is permissible, extrapolation is not).
- Step 5** Read the heating capacity. If it exceeds the design criteria it is acceptable. It is quite normal for Water-Source Heat Pumps to be selected on cooling capacity only since the heating output is usually greater than the cooling capacity.
- Step 6** Determine the correction factors associated with the variable factors of dry bulb and wet bulb.  
  
 Corrected Total Cooling =  
 tabulated total cooling x wet bulb correction.  
 Corrected Sensible Cooling =  
 tabulated sensible cooling x wet/dry bulb correction.
- Step 7** Compare the corrected capacities to the load requirements. Normally if the capacities are within 10% of the loads, the equipment is acceptable. It is better to undersize than oversize, as undersizing improves humidity control, reduces sound levels and extends the life of the equipment.
- Step 8** When completed, calculate water temperature rise and assess the selection. If the units selected are not within 10% of the load calculations, then review what effect changing the GPM, water temperature and/or air flow and air temperature would have on the corrected capacities. If the desired capacity cannot be achieved, select the next larger or smaller unit and repeat the

procedure. Remember, when in doubt, undersize slightly for best performance.

### Example Equipment Selection For Cooling

#### Step 1 Load Determination:

Assume we have determined that the appropriate cooling load at the desired dry bulb 80°F and wet bulb 65°F conditions is as follows:

Total Cooling .....	22,100 BTUH
Sensible Cooling.....	16,500 BTUH
Entering Air Temp.....	80°F Dry Bulb / 65°F Wet Bulb

#### Step 2 Design Conditions:

Similarly, we have also obtained the following design parameters:

Entering Water Temp.....	90°F
Water Flow (Based upon 10°F rise in temp.) .....	6.0 GPM
Air Flow.....	730 CFM

#### Step 3, 4 & 5 HP Selection:

After making our preliminary selection (TEH026 - Full Load), we enter the tables at design water flow and water temperature and read Total Cooling, Sens. Cooling and Heat of Rej. capacities:

Total Cooling.....	24,200 BTUH
Sensible Cooling.....	16,300 BTUH
Heat of Rejection.....	29,900 BTUH

#### Step 6 & 7 Entering Air and Airflow Corrections:

Next, we determine our correction factors.

Table	Ent Air	Air Flow	Corrected
Corrected Total Cooling =	24,200 x 0.975	x 0.978 =	23,076
Corrected Sens Cooling =	16,300 x 1.096	x 0.926 =	16,543
Corrected Heat of Rejection =	29,900 x 0.979	x 0.978 =	28,628

#### Step 8 Water Temperature Rise Calculation & Assessment:

Actual Temperature Rise.....	9.5°F
------------------------------	-------

When we compare the Corrected Total Cooling and Corrected Sensible Cooling figures with our load requirements stated in Step 1, we discover that our selection is within +/- 10% of our sensible load requirement. Furthermore, we see that our Corrected Total Cooling figure is within 1,000 Btuh of the actual indicated load.

# HZ Series Nomenclature

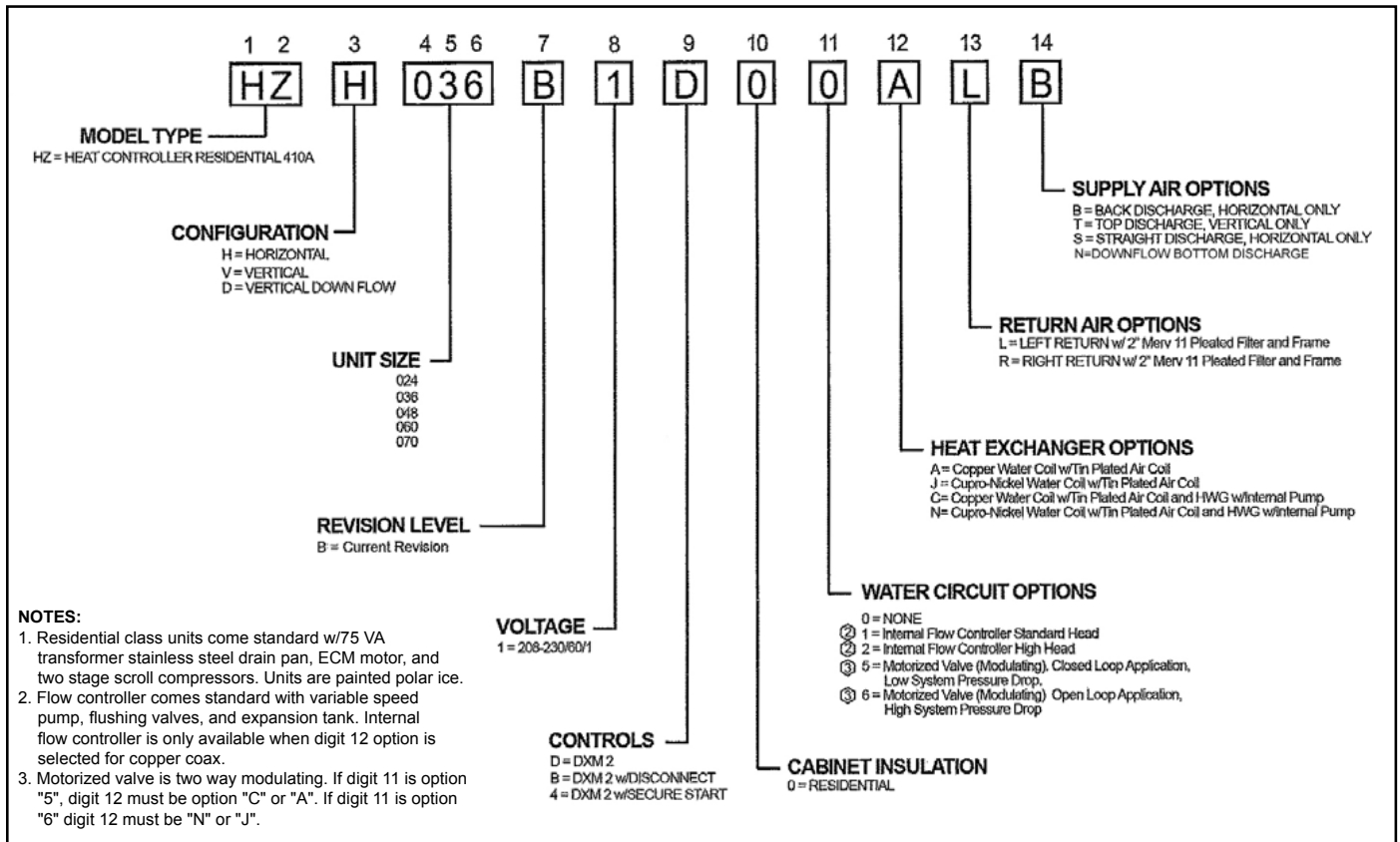

Note: Above model nomenclature is a general reference. Not all configurations are available on all models. Consult engineering submittal for detailed information.

**ClimaDry II Option Notes:**

Unit minimum entering air temperature when in dehumidification or cooling mode is 65°F DB. Operation below this minimum may result in nuisance faults. A thermostat with dehumidification mode or a thermostat and separate humidistat or dehumidistat is required for activation and control of ClimaDry II.

# Performance Data AHRI/ASHRAE/ISO 13256-1

## ASHRAE/AHRI/ISO 13256-1. English (I-P) Units

Model	Water Loop Heat Pump				Ground Water Heat Pump				Ground Loop Heat Pump			
	Cooling 86°F		Heating 68°F		Cooling 59°F		Heating 50°F		Full Cool 77°F Part Cool 68°F		Full Heat 32°F Part Heat 41°F	
	Capacity Btuh	EER Btuh/W	Capacity Btuh	COP	Capacity Btuh	EER Btuh/W	Capacity Btuh	COP	Capacity Btuh	EER Btuh/W	Capacity Btuh	COP
HZ024 Part	19,200	19.8	23,600	7.0	22,000	34.1	19,000	5.4	20,800	28.0	16,800	5.0
HZ024 Full	25,000	17.4	31,400	6.0	28,500	26.4	25,800	5.1	26,000	19.9	20,200	4.1
HZ036 Part	27,400	20.1	32,600	6.5	30,700	34.4	27,300	5.5	29,700	29.6	23,800	4.8
HZ036 Full	37,700	17.9	45,700	5.8	42,100	26.1	37,900	5.2	39,000	20.3	29,700	4.4
HZ048 Part	36,300	18.8	42,200	6.1	41,800	32.9	34,800	5.0	39,100	27.4	29,800	4.4
HZ048 Full	48,600	16.8	56,700	5.1	55,000	25.3	46,800	4.6	49,600	19.3	36,400	4.0
HZ060 Part	46,300	18.7	54,700	6.0	53,100	32.4	44,000	5.0	51,200	26.7	38,100	4.4
HZ060 Full	61,500	16.2	77,400	5.4	71,500	24.4	63,200	4.8	66,200	18.8	48,700	3.9
HZ070 Part	53,000	16.8	64,600	5.2	60,800	28.6	53,200	4.5	58,100	23.2	46,000	3.9
HZ070 Full	68,300	15.1	85,300	4.8	77,700	22.5	71,400	4.4	71,700	16.9	55,800	3.7

Cooling capacities based upon 80.6°F DB, 66.2°F WB entering air temperature  
 Heating capacities based upon 68°F DB, 59°F WB entering air temperature  
 Ground Loop Heat Pump ratings based on 15% antifreeze solution  
 All ratings based upon operation at lower voltage of dual voltage rated models

## ASHRAE/AHRI/ISO 13256-1. Metric (S-I) Units

Model	Water Loop Heat Pump				Ground Water Heat Pump				Ground Loop Heat Pump			
	Cooling 30°C		Heating 20°C		Cooling 15°C		Heating 10°C		Full Cool 25°C Part Cool 20°C		Full Heat 0°C Part Heat 5°C	
	Capacity kW	EER W/W	Capacity kW	COP	Capacity kW	EER W/W	Capacity kW	COP	Capacity kW	EER W/W	Capacity kW	COP
HZ024 Part	5.63	5.8	6.91	7.0	6.45	10	5.57	5.4	6.09	8.2	4.92	5.0
HZ024 Full	7.32	5.1	9.20	6.0	8.35	7.7	7.56	5.1	7.62	5.8	5.92	4.1
HZ036 Part	8.03	5.9	9.55	6.5	9.00	10.1	8.00	5.5	8.70	8.7	6.97	4.8
HZ036 Full	11.05	5.2	13.39	5.8	12.34	7.7	11.10	5.2	11.43	5.9	8.70	4.4
HZ048 Part	10.64	5.5	12.36	6.1	12.25	9.6	10.20	5.0	11.46	8.0	8.73	4.4
HZ048 Full	14.24	4.9	16.61	5.1	16.11	7.4	13.71	4.6	14.53	5.7	10.67	4.0
HZ060 Part	13.57	5.5	16.03	6.0	15.56	9.5	12.90	5.0	15.01	7.8	11.17	4.4
HZ060 Full	18.02	4.7	22.68	5.4	20.96	7.2	18.52	4.8	19.40	5.5	14.27	3.9
HZ070 Part	15.53	4.9	18.93	5.2	17.82	8.4	15.59	4.5	17.03	6.8	13.48	3.9
HZ070 Full	20.02	4.4	25.00	4.8	22.77	6.6	20.93	4.4	21.01	5.0	16.35	3.7

Cooling capacities based upon 27°C DB, 19°C WB entering air temperature  
 Heating capacities based upon 20°C DB, 15°C WB entering air temperature  
 Ground Loop Heat Pump ratings based on 15% antifreeze solution  
 All ratings based upon operation at lower voltage of dual voltage rated models

## Performance Data Selection Notes - vFlow® Models

### Operation in Shaded Area: Closed Loop Application

For operation in the shaded area, appropriate levels of a proper antifreeze should be used in systems with leaving water temperatures of 40°F or below and the JW3 jumper should be clipped. This is due to the potential of the refrigerant temperature being as low as 32°F [0°C] with 40°F [4.4°C] LWT, which may lead to a nuisance cutout due to the activation of the Low Temperature Protection. JW3 should never be clipped for systems without antifreeze.

### Open Loop Application:

For operation in shaded area (below 40°F LWT) in open loop applications,  $\Delta T$  (on DXM2) should be set such that the LWT (=EWT -  $\Delta T$ ) doesn't drop below 40°F. JW3 should NEVER be clipped for systems without antifreeze.

Recommended in this range. Also Clip JW3 on DXM2 board

Heating - EAT 70°F

TD	CFM	HC	kW	COP	HE	LAT	LWT	HWC	
5	5.8	725	11.3	1.1	2.9	7.4	84	16.7	1.2
5.5	5.8	850	11.5	1.1	3.1	7.7	82	16.6	1.2
6	1.7	725	12.5	1.1	3.2	8.6	86	22.4	1.4
6.7	1.7	850	12.7	1.1	3.4	8.9	84	22.1	1.3
7.3	3.0	725	13.1	1.1	3.3	9.1	87	24.6	1.4
8	3.0	850	13.2	1.1	3.5	9.5	84	24.4	1.4
9	4.6	725	13.4	1.1	3.4	9.4	87	25.8	1.4
10	4.6	850	13.5	1.1	3.6	9.8	85	25.7	1.4
11	1.2	725	14.5	1.2	3.7	10.6	89	30.6	1.6
12	1.2	850	14.7	1.1	3.9	10.9	86	30.3	1.5
13	2.4	725	15.2	1.2	3.9	11.3	89	33.4	1.6
14	2.4	850	15.4	1.1	4.1	11.7	87	33.1	1.6
15	3.8	725	15.6	1.2	4.0	11.7	90	34.8	1.6
16	3.8	850	15.8	1.1	4.2	12.1	87	34.6	1.6
17	5.2	725	16.6	1.2	4.2	12.6	91	38.8	1.6
18	5.2	850	16.8	1.1	4.4	13.0	88	38.5	1.6
19	6.5	725	17.5	1.2	4.4	13.5	92	41.5	1.6
20	6.5	850	17.7	1.1	4.7	14.0	89	41.2	1.6

### Performance Data Selection Notes - Models without vFlow®

For operation in the shaded area when water is used in lieu of an antifreeze solution, the LWT (Leaving Water Temperature) must be calculated. Flow must be maintained to a level such that the LWT is maintained above 40°F [4.4°C] when the JW3 jumper is not clipped (see example below). Otherwise, appropriate levels of a proper antifreeze solution should be used in systems with leaving water temperatures of 40°F [4.4°C] or below and the JW3 jumper should be clipped. This is due to the potential of the refrigerant temperature being as low as 32°F [0°C] with 40°F [4.4°C] LWT, which may lead to a nuisance cutout due to the activation of the Low Temperature Protection. JW3 should never be clipped for standard range equipment or systems without antifreeze.

Example:

At 50°F EWT (Entering Water Temperature) and 1.5 gpm/ton, a 3 ton unit has a HE of 22,500 Btuh. To calculate LWT, rearrange the formula for HE as follows:

HE = TD x GPM x 500, where HE = Heat of Extraction (Btuh);  
 TD = temperature difference (EWT - LWT) and GPM = U.S. Gallons per Minute.

$$TD = HE / (GPM \times 500)$$

$$TD = 22,500 / (4.5 \times 500)$$

$$TD = 10^\circ F$$

$$LWT = EWT - TD$$

$$LWT = 50 - 10 = 40^\circ F$$

In this example, as long as the EWT does not fall below 50°F, the system will operate as designed. For EWTs below 50°F, higher flow rates will be required (open loop systems, for example, require at least 2 gpm/ton when EWT is below 50°F).

Heating - EAT 70°F

ENTER	Airflow CFM	HC	kW	HE	LAT	COP
	825	11.7	1.02	8.4	83.2	3.38
	710	13.6	1.09	10.1	87.8	3.66
38.3	825	13.8	1.06	10.3	85.5	3.81
39.2	710	14.2	1.09	10.7	88.5	3.81
39.2	825	14.4	1.06	10.9	86.1	3.97
39.8	710	14.4	1.09	10.9	88.8	3.86
39.8	825	14.6	1.06	11.1	86.3	4.02
35.3	710	16.1	1.15	12.3	90.9	4.08
35.3	825	16.2	1.12	12.6	88.2	4.25
37.9	710	16.7	1.15	13.0	91.8	4.25
37.9	825	16.9	1.12	13.3	89.0	4.42
38.3	710	16.9	1.16	13.2	92.1	4.30
38.3	825	17.1	1.12	13.5	89.2	4.47
30.7	710	18.3	1.18	14.5	93.9	4.56
30.7	825	18.5	1.14	14.8	90.8	4.75
34	710	19.1	1.18	15.2	94.8	4.73
34	825	19.3	1.15	15.5	91.6	4.93
34	710	19.3	1.18	15.4	95.1	4.78
34	825	19.5	1.15	15.7	91.9	4.98
34	900	20.4	1.21	16.5	96.6	4.97
34	900	20.6	1.18	16.8	93.2	5.17
34	900	20.9	1.22	17.3	97.7	5.17

# Performance Data - HZ H/V/D 024 (Part Load), No vFlow<sup>®</sup>

## 850 CFM Nominal (Rated) Airflow Heating, 750 CFM Nominal (Rated) Airflow Cooling

Performance capacities shown in thousands of Btuh

EWT °F	GPM	WPD		COOLING - EAT 80/67 °F							HEATING - 70°F						
		PSI	FT	CFM	TC	SC	KW	HR	EER	HWC	CFM	HC	KW	HE	LAT	COP	HWC
20	4.5	1.2	2.9								750	11.5	1.25	7.4	84.2	2.7	1.2
	4.5	1.2	2.9								850	11.7	1.20	7.6	82.7	2.9	1.2
30	2.3	0.5	1.1	660	23.1	14.6	0.60	25.2	38.8	0.7	750	13.0	1.23	8.9	86.0	3.1	1.3
	2.3	0.5	1.1	750	23.6	15.6	0.61	25.6	38.8	0.7	850	13.2	1.18	9.2	84.4	3.3	1.3
	3.4	0.8	1.8	660	22.8	14.0	0.55	24.7	41.1	0.7	750	13.6	1.22	9.5	86.8	3.3	1.3
	3.4	0.8	1.8	750	23.2	14.9	0.56	25.2	41.2	0.7	850	13.8	1.17	9.8	85.0	3.5	1.4
	4.5	1.1	2.6	660	22.5	13.5	0.54	24.3	41.9	0.7	750	13.9	1.22	9.9	87.2	3.4	1.4
40	4.5	1.1	2.6	750	22.9	14.5	0.55	24.8	41.9	0.7	850	14.1	1.16	10.2	85.4	3.6	1.4
	2.3	0.4	1.0	660	23.0	14.9	0.67	25.3	34.4	0.8	750	15.2	1.20	11.2	88.8	3.7	1.5
	2.3	0.4	1.0	750	23.5	16.0	0.68	25.8	34.4	0.8	850	15.4	1.15	11.5	86.8	3.9	1.5
	3.4	0.7	1.7	660	23.2	14.7	0.61	25.2	37.7	0.7	750	16.0	1.19	12.0	89.7	3.9	1.5
	3.4	0.7	1.7	750	23.6	15.8	0.63	25.7	37.7	0.7	850	16.2	1.14	12.3	87.6	4.2	1.6
50	4.5	1.1	2.5	660	23.1	14.5	0.59	25.1	39.1	0.7	750	16.4	1.18	12.4	90.2	4.1	1.6
	4.5	1.1	2.5	750	23.5	15.5	0.60	25.6	39.2	0.7	850	16.6	1.13	12.8	88.1	4.3	1.6
	2.3	0.4	1.0	660	22.4	14.9	0.76	25.0	29.6	1.1	750	17.4	1.17	13.4	91.5	4.4	1.7
	2.3	0.4	1.0	750	22.9	15.9	0.77	25.5	29.6	1.1	850	17.7	1.12	13.8	89.2	4.6	1.7
	3.4	0.7	1.6	660	22.9	15.0	0.69	25.3	33.1	0.9	750	18.3	1.16	14.4	92.6	4.6	1.7
60	3.4	0.7	1.6	750	23.3	16.0	0.70	25.7	33.1	0.9	850	18.6	1.11	14.8	90.3	4.9	1.8
	4.5	1.0	2.3	660	23.1	14.9	0.66	25.3	34.9	0.8	750	18.9	1.16	14.9	93.3	4.8	1.8
	4.5	1.0	2.3	750	23.5	16.0	0.67	25.8	34.9	0.8	850	19.1	1.11	15.4	90.8	5.1	1.8
	2.3	0.4	1.0	660	21.5	14.5	0.86	24.4	24.9	1.5	750	19.6	1.15	15.7	94.3	5.0	1.8
	2.3	0.4	1.0	750	21.9	15.5	0.88	24.9	24.9	1.5	850	19.9	1.10	16.2	91.7	5.3	1.9
70	3.4	0.7	1.6	660	22.2	14.8	0.79	24.9	28.2	1.2	750	20.8	1.14	16.9	95.6	5.3	1.9
	3.4	0.7	1.6	750	22.6	15.8	0.80	25.3	28.3	1.2	850	21.1	1.09	17.3	92.9	5.6	1.9
	4.5	1.0	2.3	660	22.5	14.9	0.75	25.0	30.0	1.1	750	21.4	1.14	17.5	96.4	5.5	2.0
	4.5	1.0	2.3	750	22.9	15.9	0.76	25.5	30.0	1.1	850	21.7	1.09	18.0	93.6	5.8	2.0
	2.3	0.4	1.0	660	20.3	14.0	0.98	23.6	20.7	2.0	750	21.9	1.14	18.0	97.1	5.7	2.0
80	2.3	0.4	1.0	750	20.7	15.0	1.00	24.1	20.7	2.0	850	22.2	1.09	18.5	94.2	6.0	2.0
	3.4	0.7	1.6	660	21.1	14.4	0.90	24.2	23.6	1.6	750	23.2	1.13	19.3	98.7	6.0	2.1
	3.4	0.7	1.6	750	21.5	15.4	0.91	24.6	23.6	1.6	850	23.6	1.09	19.9	95.7	6.4	2.1
	4.5	1.0	2.2	660	21.5	14.5	0.85	24.4	25.2	1.4	750	24.0	1.13	20.1	99.6	6.2	2.2
	4.5	1.0	2.2	750	21.9	15.6	0.87	24.9	25.2	1.4	850	24.3	1.09	20.6	96.5	6.6	2.2
85	2.3	0.4	1.0	660	18.9	13.4	1.12	22.7	16.9	2.6	750	24.3	1.13	20.4	100.0	6.3	2.2
	2.3	0.4	1.0	750	19.3	14.3	1.14	23.2	16.9	2.6	850	24.6	1.09	20.9	96.8	6.6	2.2
	3.4	0.7	1.5	660	19.8	13.8	1.02	23.3	19.4	2.2	750	25.8	1.14	21.8	101.9	6.6	2.3
	3.4	0.7	1.5	750	20.2	14.8	1.04	23.8	19.4	2.2	850	26.2	1.09	22.4	98.5	7.0	2.3
	4.5	0.9	2.2	660	20.3	14.0	0.98	23.6	20.7	1.9	750	26.7	1.14	22.7	102.9	6.8	2.3
90	4.5	0.9	2.2	750	20.7	15.0	1.00	24.1	20.8	2.0	850	27.1	1.10	23.3	99.5	7.2	2.3
	2.3	0.4	1.0	660	17.5	12.7	1.27	21.8	13.7	3.4	750	26.7	1.14	22.7	103.0	6.8	2.3
	2.3	0.4	1.0	750	17.8	13.6	1.30	22.2	13.7	3.4	850	27.1	1.10	23.3	99.5	7.2	2.3
	3.4	0.7	1.5	660	18.4	13.1	1.17	22.4	15.7	2.9	750	28.5	1.16	24.4	105.1	7.2	2.4
	3.4	0.7	1.5	750	18.7	14.1	1.19	22.8	15.7	2.9	850	28.9	1.11	25.1	101.4	7.6	2.4
100	4.5	0.9	2.2	660	18.9	13.4	1.12	22.7	16.8	2.6	750	29.5	1.17	25.4	106.4	7.4	2.5
	4.5	0.9	2.2	750	19.2	14.3	1.14	23.1	16.9	2.7	850	29.9	1.12	26.1	102.6	7.8	2.5
	2.3	0.4	1.0	660	16.0	12.1	1.45	21.0	11.0	4.3							
	2.3	0.4	1.0	750	16.3	13.0	1.48	21.4	11.1	4.3							
	3.4	0.7	1.5	660	16.9	12.5	1.34	21.5	12.6	3.7							
110	3.4	0.7	1.5	750	17.2	13.4	1.36	21.9	12.6	3.8							
	4.5	0.9	2.1	660	17.4	12.7	1.28	21.8	13.5	3.4							
	4.5	0.9	2.1	750	17.7	13.6	1.31	22.2	13.6	3.5							
	2.3	0.4	0.9	660	14.6	11.6	1.65	20.3	8.9	5.3							
	2.3	0.4	0.9	750	14.9	12.4	1.68	20.6	8.9	5.4							
120	3.4	0.7	1.5	660	15.4	11.9	1.53	20.6	10.1	4.7							
	3.4	0.7	1.5	750	15.7	12.7	1.56	21.0	10.1	4.8							
	4.5	0.9	2.1	660	15.9	12.1	1.47	20.9	10.8	4.3							
	4.5	0.9	2.1	750	16.2	12.9	1.49	21.3	10.8	4.4							
	2.3	0.4	0.9	660	13.4	11.3	1.87	19.8	7.2	6.5							
	2.3	0.4	0.9	750	13.7	12.1	1.91	20.2	7.2	6.6							
	3.4	0.6	1.4	660	14.1	11.5	1.74	20.0	8.1	5.8							
	3.4	0.6	1.4	750	14.4	12.3	1.77	20.4	8.1	5.9							
	4.5	0.9	2.0	660	14.5	11.6	1.67	20.2	8.6	5.4							
	4.5	0.9	2.0	750	14.7	12.4	1.71	20.6	8.6	5.5							

Interpolation is permissible, extrapolation is not. All performance data is based on the lower voltage of dual voltage units. Performance stated is at the rated power supply, performance may vary as the power supply varies from the rated. Table is with entering air of 80°F DB and 67°F WB in cooling, and 70°F DB in heating. AHRI/ISO certified conditions are 80.6°F DB and 66.2°F WB in cooling and 68°F DB in heating. Table does not reflect fan or pump power corrections for AHRI/ISO conditions. See performance correction tables for operating conditions other than those listed above. See performance data selection notes for operation in the shaded areas. Operation below 40°F EWT is based on a 15% methanol antifreeze solution. Operation below 60°F EWT requires optional extended range insulated water and refrigerant circuits to avoid condensation within the unit cabinet.



# Performance Data - HZ H/V/D 024 (Full Load), No vFlow®

950 CFM Nominal (Rated) Airflow Heating, 850 CFM Nominal (Rated) Airflow Cooling

Performance capacities shown in thousands of Btu/h

EWT °F	GPM	WPD		COOLING - EAT 80/67 °F							HEATING - 70°F													
		PSI	FT	CFM	TC	SC	kW	HR	EER	HWC	CFM	HC	kW	HE	LAT	COP	HWC							
20	6.0	1.9	4.4	750	30.1	18.1	0.99	33.4	30.3	0.8	840	16.5	1.73	10.7	82.7	2.7	1.1							
	6.0	1.9	4.4								950	16.8	1.68	11.0	81.4	2.9	1.2							
30	3.0	0.7	1.6								850	30.6	19.4	1.03	34.1	29.7	0.8	840	18.2	1.70	12.6	84.3	3.1	1.3
	3.0	0.7	1.6								850	30.6	19.4	1.03	34.1	29.7	0.8	950	18.5	1.64	12.9	82.8	3.3	1.3
	4.5	1.1	2.6								850	29.8	17.6	0.93	32.8	32.1	0.7	840	19.1	1.68	13.4	85.0	3.3	1.3
	4.5	1.1	2.6								850	30.3	18.9	0.96	33.6	31.5	0.7	950	19.4	1.63	13.8	83.4	3.5	1.4
	6.0	1.8	4.0								750	29.4	17.3	0.90	32.4	32.8	0.7	840	19.5	1.68	13.9	85.4	3.4	1.4
	6.0	1.8	4.0								850	29.9	18.6	0.93	33.1	32.2	0.7	950	19.8	1.62	14.3	83.8	3.6	1.4
40	3.0	0.6	1.5								750	29.8	18.2	1.08	33.5	27.5	1.1	840	21.0	1.66	15.4	86.7	3.8	1.5
	3.0	0.6	1.5								850	30.4	19.6	1.12	34.2	27.0	1.1	950	21.3	1.61	15.8	85.0	3.9	1.5
	4.5	1.1	2.5								750	30.1	18.1	1.01	33.5	29.6	0.9	840	22.0	1.65	16.5	87.6	4.0	1.5
	4.5	1.1	2.5								850	30.6	19.5	1.05	34.2	29.1	0.9	950	22.4	1.60	16.9	85.8	4.2	1.6
	6.0	1.6	3.8								750	30.0	18.0	0.98	33.3	30.6	0.8	840	22.6	1.64	17.1	88.0	4.1	1.6
	6.0	1.6	3.8								850	30.6	19.3	1.02	34.0	30.1	0.8	950	23.0	1.59	17.5	86.2	4.3	1.6
50	3.0	0.6	1.4	750	29.1	18.0	1.19	33.1	24.5	1.5	840	23.8	1.64	18.2	89.2	4.4	1.7							
	3.0	0.6	1.4	850	29.6	19.4	1.23	33.8	24.1	1.5	950	24.1	1.59	18.7	87.2	4.6	1.7							
	4.5	1.0	2.3	750	29.7	18.2	1.11	33.4	26.8	1.2	840	25.1	1.64	19.5	90.2	4.7	1.7							
	4.5	1.0	2.3	850	30.2	19.6	1.15	34.1	26.3	1.2	950	25.4	1.59	20.0	88.1	4.9	1.8							
	6.0	1.6	3.6	750	29.9	18.2	1.07	33.5	27.9	1.1	840	25.8	1.64	20.2	90.8	4.8	1.8							
	6.0	1.6	3.6	850	30.4	19.6	1.11	34.2	27.4	1.1	950	26.2	1.59	20.7	88.6	5.1	1.8							
60	3.0	0.6	1.3	750	27.9	17.6	1.30	32.3	21.5	1.9	840	26.7	1.64	21.1	91.6	5.1	1.8							
	3.0	0.6	1.3	850	28.4	18.9	1.35	33.0	21.1	1.9	950	27.1	1.59	21.6	89.4	5.3	1.9							
	4.5	1.0	2.3	750	28.8	17.9	1.21	32.9	23.7	1.6	840	28.2	1.65	22.5	92.9	5.4	1.9							
	4.5	1.0	2.3	850	29.3	19.3	1.26	33.6	23.3	1.6	950	28.6	1.60	23.1	90.5	5.6	1.9							
	6.0	1.5	3.5	750	29.2	18.1	1.17	33.1	24.9	1.4	840	29.0	1.66	23.3	93.6	5.6	1.9							
	6.0	1.5	3.5	850	29.7	19.4	1.22	33.8	24.4	1.4	950	29.4	1.61	24.0	91.1	5.8	2.0							
70	3.0	0.6	1.3	750	26.4	17.0	1.43	31.3	18.5	2.3	840	29.6	1.67	23.9	94.2	5.7	2.0							
	3.0	0.6	1.3	850	26.9	18.3	1.48	32.0	18.2	2.4	950	30.1	1.61	24.6	91.7	6.0	2.0							
	4.5	1.0	2.2	750	27.5	17.5	1.33	32.0	20.6	2.1	840	31.4	1.69	25.6	95.6	6.1	2.1							
	4.5	1.0	2.2	850	28.0	18.8	1.38	32.7	20.3	2.1	950	31.8	1.64	26.2	93.0	6.4	2.1							
	6.0	1.5	3.4	750	28.0	17.7	1.29	32.4	21.8	1.9	840	32.3	1.71	26.5	96.4	6.3	2.2							
	6.0	1.5	3.4	850	28.5	19.0	1.33	33.1	21.4	1.9	950	32.8	1.66	27.2	93.7	6.6	2.2							
80	3.0	0.6	1.3	750	24.8	16.3	1.58	30.2	15.7	2.9	840	32.6	1.72	26.7	96.7	6.3	2.2							
	3.0	0.6	1.3	850	25.2	17.5	1.64	30.8	15.4	3.0	950	33.1	1.66	27.5	94.0	6.6	2.2							
	4.5	0.9	2.2	750	26.0	16.8	1.47	31.0	17.6	2.5	840	34.7	1.77	28.6	98.4	6.7	2.3							
	4.5	0.9	2.2	850	26.4	18.1	1.53	31.6	17.3	2.6	950	35.2	1.71	29.4	95.5	7.0	2.3							
	6.0	1.4	3.3	750	26.5	17.0	1.42	31.4	18.7	2.3	840	35.8	1.80	29.6	99.4	6.9	2.3							
	6.0	1.4	3.3	850	27.0	18.3	1.47	32.0	18.3	2.4	950	36.3	1.74	30.4	96.4	7.2	2.3							
85	3.0	0.6	1.3	750	23.9	15.9	1.7	29.6	14.4	3.3	840	34.2	1.76	28.2	98.1	6.6	2.2							
	3.0	0.6	1.3	850	24.4	17.1	1.73	30.2	14.2	3.4	950	34.7	1.7	28.9	95.2	6.9	2.3							
	4.5	0.9	2.2	750	25.1	16.4	1.55	30.4	16.3	2.9	840	36.4	1.8	30.1	99.9	7.0	2.3							
	4.5	0.9	2.2	850	25.5	17.7	1.61	31.0	16.0	2.9	950	36.9	1.8	30.9	96.8	7.3	2.4							
	6.0	1.4	3.3	750	25.7	16.7	1.50	30.8	17.2	2.7	840	37.6	1.9	31.2	100.9	7.2	2.3							
	6.0	1.4	3.3	850	26.1	17.9	1.55	31.4	16.9	2.7	950	38.2	1.8	32.0	97.8	7.5	2.4							
90	3.0	0.6	1.3	750	23.1	15.5	1.75	29.0	13.2	3.7	840	35.8	1.80	29.6	99.4	6.9	2.3							
	3.0	0.6	1.3	850	23.5	16.7	1.81	29.7	12.9	3.7	950	36.3	1.74	30.4	96.4	7.2	2.3							
	4.5	0.9	2.2	750	24.3	16.1	1.63	29.8	14.9	3.2	840	38.1	1.87	31.6	101.3	7.3	2.3							
	4.5	0.9	2.2	850	24.7	17.3	1.69	30.4	14.6	3.3	950	38.7	1.81	32.5	98.1	7.6	2.4							
	6.0	1.4	3.2	750	24.9	16.3	1.57	30.2	15.8	3.0	840	39.4	1.92	32.8	102.5	7.4	2.4							
	6.0	1.4	3.2	850	25.3	17.5	1.63	30.9	15.5	3.0	950	40.0	1.86	33.6	99.1	7.8	2.5							
100	3.0	0.6	1.3	750	21.3	14.8	1.95	28.0	10.9	4.4														
	3.0	0.6	1.3	850	21.7	15.9	2.02	28.6	10.7	4.5														
	4.5	0.9	2.1	750	22.5	15.3	1.82	28.7	12.4	3.9														
	4.5	0.9	2.1	850	22.9	16.4	1.88	29.3	12.1	4.0														
	6.0	1.4	3.2	750	23.1	15.5	1.75	29.0	13.2	3.7														
	6.0	1.4	3.2	850	23.5	16.7	1.82	29.7	12.9	3.7														
110	3.0	0.6	1.3	750	19.7	14.2	2.18	27.1	9.0	5.3														
	3.0	0.6	1.3	850	20.0	15.2	2.26	27.7	8.8	5.4														
	4.5	0.9	2.1	750	20.7	14.6	2.03	27.7	10.2	4.7														
	4.5	0.9	2.1	850	21.1	15.7	2.11	28.2	10.0	4.8														
	6.0	1.4	3.1	750	21.3	14.8	1.96	28.0	10.8	4.4														
	6.0	1.4	3.1	850	21.6	15.9	2.03	28.6	10.6	4.5														
120	3.0	0.5	1.2	750	18.2	13.7	2.46	26.6	7.4	6.2														
	3.0	0.5	1.2	850	18.5	14.7	2.55	27.2	7.3	6.4														
	4.5	0.9	2.0	750	19.1	14.0	2.28	26.9	8.3	5.6														
	4.5	0.9	2.0	850	19.4	15.0	2.37	27.5	8.2	5.8														
	6.0	1.3	3.1	750	19.5	14.1	2.20	27.1	8.9	5.3														
	6.0	1.3	3.1	850	19.9	15.2	2.28	27.7	8.7	5.5														

Interpolation is permissible, extrapolation is not. All performance data is based on the lower voltage of dual voltage units.

Performance stated is at the rated power supply, performance may vary as the power supply varies from the rated.

Table is with entering air of 80°F DB and 67°F WB in cooling, and 70°F DB in heating.

AHRI/ISO certified conditions are 80.6°F DB and 66.2°F WB in cooling and 68°F DB in heating.

Table does not reflect fan or pump power corrections for AHRI/ISO conditions.

See performance correction tables for operating conditions other than those listed above. See performance data selection notes for operation in the shaded areas.

Operation below 40°F EWT is based on a 15% methanol antifreeze solution.

Operation below 60°F EWT requires optional extended range insulated water and refrigerant circuits to avoid condensation within the unit cabinet.



# Performance Data - HZ H/V/D 036 (Part Load), No vFlow®

## 1000 CFM Nominal (Rated) Airflow Heating, 1000 CFM Nominal (Rated) Airflow Cooling

Performance capacities shown in thousands of Btu/h

EWT °F	GPM	WPD		COOLING - EAT 80/67 °F							HEATING - 70°F						
		PSI	FT	CFM	TC	SC	kW	HR	EER	HWC	CFM	HC	kW	HE	LAT	COP	HWC
20	6.0	2.5	5.7								880	16.9	1.65	11.5	87.8	3.0	1.6
	6.0	2.5	5.7								1000	17.2	1.58	11.8	85.9	3.2	1.7
30	3.0	0.9	2.1	880	32.7	19.9	0.82	35.5	39.6	0.9	880	18.9	1.65	13.4	89.8	3.4	1.8
	3.0	0.9	2.1	1000	33.3	21.3	0.84	36.2	39.7	0.9	1000	19.1	1.58	13.7	87.7	3.5	1.8
	4.5	1.5	3.5	880	31.0	18.3	0.74	33.5	42.1	1.0	880	19.9	1.64	14.4	90.9	3.6	1.9
	4.5	1.5	3.5	1000	31.6	19.6	0.75	34.1	42.1	1.0	1000	20.2	1.57	14.8	88.7	3.8	1.9
	6.0	2.2	5.1	880	29.6	17.3	0.71	32.1	41.9	1.1	880	20.4	1.64	14.9	91.5	3.7	1.9
	6.0	2.2	5.1	1000	30.2	18.5	0.72	32.7	42.0	1.1	1000	20.7	1.57	15.4	89.2	3.9	2.0
40	3.0	0.8	1.9	880	33.1	20.7	0.94	36.4	35.2	0.9	880	21.9	1.64	16.4	93.1	3.9	2.1
	3.0	0.8	1.9	1000	33.8	22.2	0.96	37.1	35.2	0.9	1000	22.2	1.57	16.9	90.6	4.2	2.1
	4.5	1.4	3.2	880	32.9	20.1	0.84	35.8	39.0	0.8	880	23.1	1.64	17.6	94.3	4.1	2.2
	4.5	1.4	3.2	1000	33.6	21.5	0.86	36.5	39.0	0.8	1000	23.5	1.57	18.1	91.7	4.4	2.2
	6.0	2.0	4.7	880	32.4	19.6	0.80	35.1	40.7	0.8	880	23.8	1.64	18.3	95.1	4.3	2.2
	6.0	2.0	4.7	1000	33.0	20.9	0.81	35.8	40.8	0.9	1000	24.1	1.57	18.8	92.4	4.5	2.3
50	3.0	0.8	1.8	880	32.3	20.7	1.08	36.0	29.9	1.1	880	24.9	1.64	19.4	96.2	4.5	2.3
	3.0	0.8	1.8	1000	33.0	22.2	1.10	36.7	30.0	1.1	1000	25.3	1.57	19.9	93.4	4.7	2.4
	4.5	1.3	3.0	880	33.1	20.7	0.96	36.4	34.4	0.9	880	26.3	1.64	20.7	97.7	4.7	2.5
	4.5	1.3	3.0	1000	33.7	22.2	0.98	37.1	34.4	0.9	1000	26.7	1.57	21.3	94.7	5.0	2.5
	6.0	1.9	4.4	880	33.2	20.6	0.91	36.3	36.3	0.9	880	27.1	1.64	21.5	98.5	4.8	2.5
	6.0	1.9	4.4	1000	33.8	22.0	0.93	37.0	36.4	0.9	1000	27.5	1.57	22.1	95.4	5.1	2.6
60	3.0	0.8	1.8	880	30.8	20.2	1.24	35.0	24.9	1.5	880	27.9	1.65	22.3	99.3	5.0	2.6
	3.0	0.8	1.8	1000	31.4	21.6	1.26	35.7	24.9	1.5	1000	28.3	1.58	22.9	96.2	5.2	2.6
	4.5	1.3	2.9	880	32.1	20.6	1.11	35.9	28.9	1.2	880	29.5	1.65	23.8	101.0	5.2	2.7
	4.5	1.3	2.9	1000	32.7	22.1	1.13	36.6	29.0	1.3	1000	29.9	1.58	24.5	97.7	5.5	2.8
	6.0	1.8	4.2	880	32.6	20.8	1.05	36.2	31.0	1.1	880	30.4	1.65	24.7	102.0	5.4	2.8
	6.0	1.8	4.2	1000	33.2	22.2	1.07	36.9	31.1	1.2	1000	30.8	1.58	25.4	98.5	5.7	2.8
70	3.0	1.2	2.7	880	28.8	19.4	1.41	33.6	20.4	2.1	880	30.8	1.66	25.2	102.4	5.4	2.8
	3.0	1.2	2.7	1000	29.4	20.7	1.44	34.3	20.4	2.2	1000	31.3	1.59	25.9	99.0	5.8	2.9
	4.5	1.9	4.4	880	30.4	20.0	1.28	34.7	23.8	1.8	880	32.7	1.67	27.0	104.4	5.7	2.9
	4.5	1.9	4.4	1000	31.0	21.4	1.30	35.4	23.8	1.8	1000	33.2	1.60	27.7	100.7	6.1	3.0
	6.0	2.9	6.6	880	31.1	20.3	1.21	35.2	25.8	1.6	880	33.7	1.67	28.0	105.5	5.9	3.0
	6.0	2.9	6.6	1000	31.7	21.7	1.23	35.9	25.8	1.6	1000	34.2	1.60	28.7	101.7	6.3	3.1
80	3.0	1.2	2.7	880	26.6	18.4	1.61	32.1	16.5	3.0	880	33.9	1.67	28.1	105.6	5.9	3.0
	3.0	1.2	2.7	1000	27.1	19.7	1.64	32.7	16.5	3.0	1000	34.3	1.60	28.9	101.8	6.3	3.1
	4.5	1.9	4.3	880	28.3	19.1	1.46	33.2	19.3	2.5	880	36.0	1.69	30.2	107.9	6.2	3.2
	4.5	1.9	4.3	1000	28.8	20.5	1.49	33.9	19.3	2.6	1000	36.5	1.62	31.0	103.8	6.6	3.2
	6.0	2.8	6.5	880	29.1	19.5	1.38	33.8	21.0	2.3	880	37.2	1.70	31.3	109.2	6.4	3.3
	6.0	2.8	6.5	1000	29.7	20.9	1.41	34.5	21.0	2.3	1000	37.8	1.63	32.2	105.0	6.8	3.3
85	3.0	1.2	2.7	880	25.5	17.9	1.7	31.4	14.9	3.5	880	35.4	1.68	29.6	107.3	6.2	3.1
	3.0	1.2	2.7	1000	26.0	19.2	1.76	32.0	14.9	3.6	1000	35.9	1.6	30.4	103.3	6.5	3.2
	4.5	1.9	4.3	880	27.1	18.6	1.57	32.4	17.4	3.0	880	37.8	1.7	31.8	109.7	6.5	3.3
	4.5	1.9	4.3	1000	27.6	19.9	1.60	33.1	17.5	3.0	1000	38.3	1.6	32.7	105.5	6.9	3.4
	6.0	2.8	6.4	880	28.0	19.0	1.49	33.0	18.9	2.7	880	39.1	1.7	33.1	111.1	6.7	3.4
	6.0	2.8	6.4	1000	28.5	20.3	1.52	33.7	19.0	2.8	1000	39.7	1.7	34.0	106.7	7.0	3.4
90	3.0	1.2	2.7	880	24.4	17.4	1.84	30.7	13.3	4.0	880	37.0	1.70	31.1	108.9	6.4	3.3
	3.0	1.2	2.7	1000	24.9	18.7	1.87	31.3	13.3	4.1	1000	37.5	1.63	32.0	104.7	6.7	3.3
	4.5	1.9	4.3	880	26.0	18.1	1.67	31.7	15.6	3.4	880	39.5	1.72	33.5	111.6	6.7	3.4
	4.5	1.9	4.3	1000	26.5	19.4	1.70	32.3	15.6	3.5	1000	40.1	1.65	34.4	107.1	7.1	3.5
	6.0	2.8	6.3	880	26.8	18.5	1.59	32.2	16.9	3.2	880	41.0	1.74	34.9	113.1	6.9	3.5
	6.0	2.8	6.3	1000	27.3	19.8	1.62	32.9	16.9	3.2	1000	41.5	1.67	35.8	108.5	7.3	3.6
100	3.0	1.2	2.7	880	22.5	16.6	2.09	29.6	10.7	5.2							
	3.0	1.2	2.7	1000	22.9	17.8	2.13	30.1	10.7	5.3							
	4.5	1.8	4.2	880	23.8	17.1	1.91	30.3	12.5	4.6							
	4.5	1.8	4.2	1000	24.2	18.4	1.94	30.9	12.5	4.7							
	6.0	2.7	6.3	880	24.5	17.5	1.83	30.7	13.4	4.3							
	6.0	2.7	6.3	1000	25.0	18.7	1.86	31.3	13.4	4.4							
110	3.0	1.1	2.6	880	21.0	16.3	2.39	29.1	8.8	6.7							
	3.0	1.1	2.6	1000	21.4	17.4	2.43	29.7	8.8	6.8							
	4.5	1.8	4.2	880	21.9	16.4	2.19	29.3	10.0	5.9							
	4.5	1.8	4.2	1000	22.3	17.6	2.23	29.9	10.0	6.1							
	6.0	2.7	6.2	880	22.5	16.6	2.09	29.6	10.7	5.6							
	6.0	2.7	6.2	1000	22.9	17.8	2.13	30.2	10.7	5.7							
120	3.0	1.1	2.5	880	20.4	16.8	2.75	29.8	7.4	8.4							
	3.0	1.1	2.5	1000	20.8	17.9	2.80	30.4	7.4	8.6							
	4.5	1.7	4.0	880	20.7	16.3	2.50	29.2	8.3	7.6							
	4.5	1.7	4.0	1000	21.1	17.5	2.55	29.8	8.3	7.7							
	6.0	2.6	6.0	880	21.0	16.3	2.40	29.1	8.8	7.2							
	6.0	2.6	6.0	1000	21.4	17.4	2.44	29.7	8.8	7.3							

Interpolation is permissible, extrapolation is not. All performance data is based on the lower voltage of dual voltage units. Performance stated is at the rated power supply, performance may vary as the power supply varies from the rated. Table is with entering air of 80°F DB and 67°F WB in cooling, and 70°F DB in heating. AHRI/ISO certified conditions are 80.6°F DB and 66.2°F WB in cooling and 68°F DB in heating. Table does not reflect fan or pump power corrections for AHRI/ISO conditions. See performance correction tables for operating conditions other than those listed above. See performance data selection notes for operation in the shaded areas. Operation below 40°F EWT is based on a 15% methanol antifreeze solution. Operation below 60°F EWT requires optional extended range insulated water and refrigerant circuits to avoid condensation within the unit cabinet.

## Performance Data - HZ H/V/D 036 (Full Load), No vFlow<sup>®</sup>

1250 CFM Nominal (Rated) Airflow Heating, 1250 CFM Nominal (Rated) Airflow Cooling

Performance capacities shown in thousands of Btu/h

EWT °F	GPM	WPD		COOLING - EAT 80/67 °F							HEATING - 70°F						
		PSI	FT	CFM	TC	SC	kW	HR	EER	HWC	CFM	HC	kW	HE	LAT	COP	HWC
20	9.0	4.3	9.9	1100	25.2	2.23	17.8	91.2	3.3	2.0	1250	25.6	2.16	18.2	89.0	3.5	2.1
	9.0	4.3	9.9	1100	27.7	2.25	20.1	93.3	3.6	2.3	1250	28.1	2.18	20.7	90.8	3.8	2.4
30	4.5	1.5	3.5	1100	45.4	26.4	1.46	50.2	31.0	1.1	1100	29.0	2.26	21.4	94.4	3.8	2.5
	4.5	1.5	3.5	1250	46.1	28.4	1.52	51.3	30.4	1.1	1250	29.5	2.19	22.0	91.8	3.9	2.5
	6.8	2.6	6.0	1100	45.1	25.9	1.36	49.6	33.2	0.9	1100	29.7	2.26	22.1	95.0	3.9	2.6
	6.8	2.6	6.0	1250	45.9	27.8	1.41	50.7	32.6	0.9	1250	30.2	2.19	22.7	92.4	4.0	2.6
	9.0	3.9	9.1	1100	44.8	25.5	1.31	49.2	34.2	0.8	1100	44.8	25.5	1.31	49.2	34.2	0.8
40	4.5	1.4	3.2	1100	44.9	26.7	1.60	50.3	28.1	1.4	1100	31.8	2.29	24.0	96.7	4.1	2.8
	4.5	1.4	3.2	1250	45.7	28.7	1.66	51.4	27.6	1.5	1250	32.2	2.21	24.7	93.9	4.3	2.9
	6.8	2.4	5.5	1100	45.3	26.5	1.50	50.3	30.3	1.1	1100	33.3	2.30	25.5	98.1	4.2	3.0
	6.8	2.4	5.5	1250	46.1	28.5	1.55	51.4	29.8	1.2	1250	33.8	2.23	26.2	95.1	4.4	3.1
	9.0	3.6	8.4	1100	45.4	26.3	1.44	50.2	31.4	1.0	1100	34.2	2.31	26.3	98.8	4.3	3.1
50	4.5	1.3	3.0	1100	43.9	26.6	1.74	49.7	25.2	2.0	1100	35.8	2.34	27.9	100.1	4.5	3.3
	4.5	1.3	3.0	1250	44.6	28.6	1.80	50.8	24.7	2.0	1250	36.3	2.26	28.6	96.9	4.7	3.4
	6.8	2.2	5.1	1100	44.7	26.7	1.63	50.2	27.4	1.5	1100	37.6	2.36	29.6	101.6	4.7	3.5
	6.8	2.2	5.1	1250	45.5	28.7	1.69	51.3	26.9	1.6	1250	38.2	2.29	30.3	98.3	4.9	3.6
	9.0	3.4	7.9	1100	45.0	26.7	1.58	50.3	28.5	1.4	1100	38.6	2.38	30.5	102.5	4.8	3.6
60	4.5	1.3	2.9	1100	42.3	26.1	1.90	48.7	22.3	2.6	1100	39.8	2.40	31.6	103.5	4.9	3.7
	4.5	1.3	2.9	1250	43.0	28.1	1.97	49.8	21.9	2.7	1250	40.4	2.33	32.5	99.9	5.1	3.8
	6.8	2.1	4.9	1100	43.5	26.5	1.78	49.5	24.5	2.1	1100	41.9	2.44	33.5	105.2	5.0	4.0
	6.8	2.1	4.9	1250	44.3	28.5	1.84	50.6	24.0	2.2	1250	42.5	2.37	34.4	101.5	5.3	4.1
	9.0	3.3	7.5	1100	44.0	26.6	1.72	49.8	25.6	1.9	1100	43.0	2.47	34.6	106.2	5.1	4.1
70	4.5	1.2	2.9	1100	40.4	25.4	2.08	47.4	19.4	3.4	1100	43.9	2.49	35.4	106.9	5.2	4.2
	4.5	1.2	2.9	1250	41.1	27.4	2.15	48.4	19.1	3.5	1250	44.5	2.41	36.3	103.0	5.4	4.3
	6.8	2.1	4.8	1100	41.8	26.0	1.94	48.4	21.5	2.8	1100	46.2	2.54	37.5	108.9	5.3	4.5
	6.8	2.1	4.8	1250	42.6	27.9	2.02	49.4	21.1	2.9	1250	46.9	2.47	38.5	104.8	5.6	4.6
	9.0	3.1	7.2	1100	42.5	26.2	1.88	48.8	22.6	2.5	1100	47.6	2.58	38.7	110.0	5.4	4.6
80	4.5	1.2	2.9	1100	38.2	24.6	2.29	45.9	16.7	4.3	1100	48.0	2.59	39.2	110.4	5.4	4.6
	4.5	1.2	2.9	1250	38.8	26.4	2.37	46.9	16.4	4.4	1250	48.8	2.51	40.2	106.1	5.7	4.7
	6.8	2.0	4.7	1100	39.8	25.2	2.14	47.0	18.6	3.6	1100	50.8	2.67	41.6	112.7	5.6	4.9
	6.8	2.0	4.7	1250	40.5	27.1	2.21	48.0	18.3	3.7	1250	51.5	2.59	42.7	108.2	5.8	5.0
	9.0	3.1	7.1	1100	40.5	25.5	2.06	47.5	19.6	3.9	1100	52.3	2.72	42.9	114.0	5.6	5.1
85	4.5	1.2	2.9	1100	37.0	24.1	2.4	45.2	15.4	4.8	1100	50.2	2.66	41.1	112.3	5.5	4.8
	4.5	1.2	2.9	1250	37.6	25.9	2.50	46.2	15.1	4.9	1250	51.0	2.6	42.2	107.8	5.8	5.0
	6.8	2.0	4.6	1100	38.6	24.7	2.25	46.2	17.2	4.1	1100	53.1	2.8	43.7	114.7	5.7	5.1
	6.8	2.0	4.6	1250	39.3	26.6	2.33	47.2	16.9	4.2	1250	53.9	2.7	44.8	110.0	5.9	5.3
	9.0	3.0	7.0	1100	39.4	25.1	2.17	46.8	18.2	4.1	1100	54.8	2.8	45.1	116.1	5.7	5.3
90	4.5	1.2	2.9	1100	35.8	23.6	2.54	44.4	14.1	5.3	1100	52.4	2.73	43.0	114.1	5.6	5.1
	4.5	1.2	2.9	1250	36.4	25.4	2.63	45.4	13.9	5.5	1250	53.2	2.64	44.2	109.4	5.9	5.2
	6.8	2.0	4.6	1100	37.4	24.3	2.36	45.5	15.9	4.6	1100	55.5	2.84	45.7	116.7	5.7	5.4
	6.8	2.0	4.6	1250	38.1	26.1	2.45	46.4	15.6	4.7	1250	56.3	2.75	47.0	111.7	6.0	5.5
	9.0	3.0	6.9	1100	38.3	24.6	2.28	46.0	16.8	4.3	1100	57.3	2.90	47.3	118.2	5.8	5.5
100	4.5	1.2	2.8	1100	33.3	22.5	2.83	43.0	11.8	6.5	1100	58.1	2.81	48.5	113.1	6.1	5.6
	4.5	1.2	2.8	1250	33.9	24.2	2.93	43.9	11.6	6.7	1250	59.5	2.89	49.5	111.3	6.3	5.7
	6.8	2.0	4.5	1100	35.0	23.2	2.63	43.9	13.3	5.7	1100	62.1	3.06	51.3	119.6	6.1	5.8
	6.8	2.0	4.5	1250	35.6	25.0	2.72	44.9	13.1	5.9	1250	63.3	3.00	52.2	116.5	6.3	5.9
	9.0	3.0	6.8	1100	35.8	23.6	2.53	44.4	14.1	5.3	1100	64.9	3.15	53.6	121.1	6.1	5.8
110	4.5	1.2	2.8	1100	30.9	21.4	3.18	41.7	9.7	7.9	1100	66.7	3.28	54.9	125.7	6.0	5.7
	4.5	1.2	2.8	1250	31.4	23.0	3.29	42.6	9.5	8.0	1250	68.1	3.34	56.0	123.1	6.2	5.8
	6.8	1.9	4.5	1100	32.4	22.1	2.95	42.5	11.0	7.0	1100	70.1	3.43	57.2	127.9	6.0	5.7
	6.8	1.9	4.5	1250	33.0	23.8	3.05	43.4	10.8	7.1	1250	71.6	3.48	58.2	125.1	6.2	5.8
	9.0	2.9	6.7	1100	33.3	22.5	2.84	42.9	11.7	6.6	1100	73.1	3.54	59.2	129.5	6.0	5.7
120	4.5	1.1	2.6	1100	28.5	20.3	3.59	40.8	7.9	9.4	1100	74.9	3.61	60.2	132.9	5.9	5.6
	4.5	1.1	2.6	1250	29.0	21.9	3.72	41.7	7.8	9.6	1250	76.5	3.67	61.1	130.1	6.1	5.7
	6.8	1.9	4.3	1100	29.9	21.0	3.32	41.3	9.0	8.4	1100	78.1	3.73	62.1	134.3	5.9	5.6
	6.8	1.9	4.3	1250	30.5	22.6	3.44	42.2	8.8	8.6	1250	79.7	3.78	63.0	131.5	6.1	5.7
	9.0	2.9	6.6	1100	30.7	21.3	3.20	41.7	9.6	8.0	1100	81.3	3.83	64.0	135.7	5.9	5.6

Interpolation is permissible, extrapolation is not. All performance data is based on the lower voltage of dual voltage units.  
 Performance stated is at the rated power supply, performance may vary as the power supply varies from the rated.  
 Table is with entering air of 80°F DB and 67°F WB in cooling, and 70°F DB in heating.  
 AHRI/ISO certified conditions are 80.6°F DB and 66.2°F WB in cooling and 68°F DB in heating.  
 Table does not reflect fan or pump power corrections for AHRI/ISO conditions.  
 See performance correction tables for operating conditions other than those listed above. See performance data selection notes for operation in the shaded areas.  
 Operation below 40°F EWT is based on a 15% methanol antifreeze solution.  
 Operation below 60°F EWT requires optional extended range insulated water and refrigerant circuits to avoid condensation within the unit cabinet.



# Performance Data – HZ H/V/D 048 (Part Load), No vFlow®

1350 CFM Nominal (Rated) Airflow Heating, 1350 CFM Nominal (Rated) Airflow Cooling

Performance capacities shown in thousands of Btuh

EWT °F	GPM	WPD		COOLING - EAT 80/67 °F							HEATING - 70°F						
		PSI	FT	CFM	TC	SC	kW	HR	EER	HWC	CFM	HC	kW	HE	LAT	COP	HWC
20	9.0	2.3	5.4								1190	22.8	2.37	14.9	87.7	2.8	2.5
	9.0	2.3	5.4								1350	23.1	2.28	15.3	85.8	3.0	2.5
30	4.5	0.2	0.6	1190	40.9	25.0	1.11	44.7	37.0	1.0	1190	25.0	2.35	17.2	89.4	3.1	2.5
	4.5	0.2	0.6	1350	41.7	26.7	1.13	45.6	37.0	1.0	1350	25.3	2.25	17.6	87.4	3.3	2.6
	6.8	1.2	2.8	1190	39.5	22.6	1.02	43.0	38.6	1.0	1190	25.9	2.34	18.1	90.2	3.2	2.5
	6.8	1.2	2.8	1350	40.3	24.2	1.04	43.8	38.6	1.1	1350	26.3	2.24	18.6	88.0	3.4	2.6
	9.0	2.1	4.9	1190	38.5	21.2	0.99	41.9	38.9	1.1	1190	26.5	2.33	18.7	90.6	3.3	2.6
	9.0	2.1	4.9	1350	39.3	22.7	1.01	42.7	38.9	1.1	1350	26.8	2.24	19.2	88.4	3.5	2.6
40	4.5	0.2	0.4	1190	41.7	27.1	1.26	46.0	33.1	1.1	1190	28.5	2.32	20.8	92.2	3.6	2.6
	4.5	0.2	0.4	1350	42.5	29.1	1.28	46.9	33.1	1.2	1350	28.9	2.23	21.3	89.8	3.8	2.7
	6.8	1.1	2.5	1190	41.3	25.8	1.15	45.3	35.9	1.0	1190	29.8	2.32	22.0	93.2	3.8	2.7
	6.8	1.1	2.5	1350	42.1	27.6	1.17	46.2	35.9	1.0	1350	30.2	2.23	22.6	90.7	4.0	2.7
	9.0	2.0	4.6	1190	40.9	24.9	1.11	44.7	37.0	1.0	1190	30.5	2.32	22.7	93.7	3.9	2.7
	9.0	2.0	4.6	1350	41.7	26.7	1.13	45.6	37.0	1.0	1350	30.9	2.22	23.3	91.2	4.1	2.7
50	4.5	0.1	0.3	1190	41.2	28.0	1.45	46.1	28.5	1.5	1190	32.3	2.32	24.5	95.2	4.1	2.7
	4.5	0.1	0.3	1350	42.0	30.0	1.47	47.0	28.6	1.5	1350	32.8	2.22	25.2	92.5	4.3	2.8
	6.8	1.0	2.3	1190	41.7	27.5	1.31	46.1	31.7	1.2	1190	33.9	2.32	26.1	96.4	4.3	2.8
	6.8	1.0	2.3	1350	42.5	29.5	1.34	47.0	31.7	1.2	1350	34.4	2.23	26.8	93.6	4.5	2.9
	9.0	1.9	4.3	1190	41.7	27.1	1.25	46.0	33.2	1.1	1190	34.8	2.32	26.9	97.1	4.4	2.8
	9.0	1.9	4.3	1350	42.5	29.0	1.28	46.9	33.3	1.1	1350	35.3	2.23	27.7	94.2	4.6	2.9
60	4.5	0.1	0.2	1190	39.8	27.8	1.66	45.5	24.0	2.0	1190	36.3	2.33	28.4	98.3	4.6	2.9
	4.5	0.1	0.2	1350	40.6	29.8	1.69	46.4	24.1	2.1	1350	36.8	2.23	29.2	95.3	4.8	3.0
	6.8	1.0	2.2	1190	40.9	28.0	1.51	46.0	27.1	1.6	1190	38.2	2.34	30.3	99.7	4.8	3.0
	6.8	1.0	2.2	1350	41.7	30.0	1.53	46.9	27.2	1.7	1350	38.7	2.24	31.1	96.6	5.1	3.1
	9.0	1.8	4.2	1190	41.3	28.0	1.44	46.2	28.7	1.5	1190	39.2	2.34	31.3	100.5	4.9	3.0
	9.0	1.8	4.2	1350	42.1	29.9	1.46	47.0	28.8	1.5	1350	39.8	2.25	32.1	97.3	5.2	3.1
70	4.5	0.1	0.2	1190	37.9	27.1	1.90	44.4	19.9	2.5	1190	40.4	2.35	32.4	101.4	5.0	3.1
	4.5	0.1	0.2	1350	38.6	29.0	1.94	45.2	19.9	2.5	1350	41.0	2.25	33.3	98.1	5.3	3.2
	6.8	0.9	2.1	1190	39.3	27.7	1.73	45.2	22.7	2.1	1190	42.6	2.36	34.5	103.1	5.3	3.2
	6.8	0.9	2.1	1350	40.0	29.6	1.76	46.1	22.7	2.1	1350	43.2	2.26	35.5	99.6	5.6	3.3
	9.0	1.8	4.0	1190	39.9	27.9	1.65	45.5	24.2	1.9	1190	43.8	2.37	35.7	104.1	5.4	3.3
	9.0	1.8	4.0	1350	40.7	29.8	1.68	46.4	24.2	1.9	1350	44.4	2.27	36.7	100.5	5.7	3.4
80	4.5	0.1	0.3	1190	35.5	26.0	2.18	42.9	16.3	3.3	1190	44.6	2.37	36.4	104.7	5.5	3.3
	4.5	0.1	0.3	1350	36.2	27.8	2.22	43.7	16.3	3.4	1350	45.2	2.27	37.4	101.0	5.8	3.4
	6.8	0.9	2.1	1190	37.1	26.7	1.99	43.9	18.6	2.8	1190	47.0	2.38	38.8	106.6	5.8	3.5
	6.8	0.9	2.1	1350	37.8	28.6	2.03	44.7	18.6	2.9	1350	47.7	2.29	39.9	102.7	6.1	3.6
	9.0	1.7	4.0	1190	37.9	27.1	1.90	44.4	19.9	2.6	1190	48.3	2.39	40.1	107.6	5.9	3.8
	9.0	1.7	4.0	1350	38.6	29.0	1.94	45.2	19.9	2.7	1350	49.0	2.29	41.2	103.6	6.3	3.9
85	4.5	0.1	0.3	1190	34.2	25.4	2.3	42.1	14.7	3.8	1190	46.6	2.38	38.4	106.3	5.7	3.5
	4.5	0.1	0.3	1350	34.8	27.1	2.38	43.0	14.8	3.9	1350	47.3	2.3	39.5	102.4	6.1	3.5
	6.8	0.9	2.1	1190	35.8	26.1	2.14	43.1	16.9	3.3	1190	49.2	2.4	40.9	108.3	6.0	3.7
	6.8	0.9	2.1	1350	36.5	28.0	2.18	44.0	16.9	3.4	1350	49.9	2.3	42.0	104.2	6.4	3.7
	9.0	1.7	4.0	1190	36.6	26.5	2.04	43.6	18.1	3.1	1190	50.6	2.4	42.3	109.4	6.2	3.9
	9.0	1.7	4.0	1350	37.4	28.4	2.08	44.5	18.1	3.1	1350	51.3	2.3	43.4	105.2	6.5	3.9
90	4.5	0.1	0.3	1190	32.9	24.7	2.49	41.4	13.2	4.4	1190	48.7	2.39	40.4	107.9	6.0	3.6
	4.5	0.1	0.3	1350	33.5	26.5	2.54	42.2	13.2	4.4	1350	49.4	2.30	41.5	103.9	6.3	3.7
	6.8	0.9	2.1	1190	34.6	25.5	2.29	42.4	15.1	3.8	1190	51.4	2.41	43.0	110.0	6.3	3.8
	6.8	0.9	2.1	1350	35.2	27.3	2.33	43.2	15.1	3.9	1350	52.1	2.31	44.2	105.7	6.6	3.9
	9.0	1.7	3.9	1190	35.4	25.9	2.19	42.9	16.2	3.5	1190	52.8	2.41	44.4	111.1	6.4	3.9
	9.0	1.7	3.9	1350	36.1	27.8	2.23	43.7	16.2	3.6	1350	53.6	2.31	45.7	106.7	6.8	4.0
100	4.5	0.1	0.3	1190	30.2	23.5	2.84	39.9	10.6	5.6							
	4.5	0.1	0.3	1350	30.8	25.2	2.89	40.7	10.6	5.7							
	6.8	0.9	2.1	1190	31.9	24.3	2.62	40.8	12.2	5.0							
	6.8	0.9	2.1	1350	32.5	26.0	2.67	41.6	12.2	5.1							
	9.0	1.7	3.8	1190	32.7	24.6	2.51	41.3	13.0	4.7							
9.0	1.7	3.8	1350	33.3	26.4	2.56	42.1	13.0	4.7								
110	4.5	0.1	0.2	1190	27.7	22.6	3.24	38.7	8.5	7.1							
	4.5	0.1	0.2	1350	28.2	24.2	3.30	39.5	8.6	7.2							
	6.8	0.9	2.0	1190	29.2	23.1	3.00	39.4	9.7	6.3							
	6.8	0.9	2.0	1350	29.7	24.7	3.05	40.1	9.7	6.5							
	9.0	1.6	3.7	1190	30.0	23.4	2.88	39.8	10.4	6.0							
9.0	1.6	3.7	1350	30.5	25.1	2.93	40.5	10.4	6.1								
120	4.5	0.1	0.1	1190	25.4	22.0	3.69	38.0	6.9	8.7							
	4.5	0.1	0.1	1350	25.9	23.6	3.75	38.7	6.9	8.9							
	6.8	0.8	1.9	1190	26.7	22.3	3.42	38.3	7.8	7.9							
	6.8	0.8	1.9	1350	27.2	23.9	3.48	39.1	7.8	8.1							
	9.0	1.6	3.6	1190	27.4	22.5	3.29	38.6	8.3	7.5							
9.0	1.6	3.6	1350	27.9	24.1	3.35	39.3	8.3	7.7								

Interpolation is permissible, extrapolation is not. All performance data is based on the lower voltage of dual voltage units. Performance stated is at the rated power supply, performance may vary as the power supply varies from the rated. Table is with entering air of 80°F DB and 67°F WB in cooling, and 70°F DB in heating. AHRI/ISO certified conditions are 80.6°F DB and 66.2°F WB in cooling and 68°F DB in heating. Table does not reflect fan or pump power corrections for AHRI/ISO conditions. See performance correction tables for operating conditions other than those listed above. See performance data selection notes for operation in the shaded areas. Operation below 40°F EWT is based on a 15% methanol antifreeze solution. Operation below 60°F EWT requires optional extended range insulated water and refrigerant circuits to avoid condensation within the unit cabinet.

# Performance Data - HZ H/V/D 048 (Full Load), No vFlow®

1650 CFM Nominal (Rated) Airflow Heating, 1550 CFM Nominal (Rated) Airflow Cooling

Performance capacities shown in thousands of Btu/h

EWT °F	GPM	WPD		COOLING - EAT 80/67 °F							HEATING - 70°F						
		PSI	FT	CFM	TC	SC	kW	HR	EER	HWC	CFM	HC	kW	HE	LAT	COP	HWC
20	12.0	4.1	9.4								1450	31.4	3.17	20.9	90.1	2.9	3.3
	12.0	4.1	9.4								1650	31.9	3.07	21.4	87.9	3.0	3.3
30	6.0	0.9	2.1	1364	48.8	27.0	1.80	54.8	27.0	1.8	1450	34.7	3.16	24.2	92.2	3.2	3.4
	6.0	0.9	2.1	1550	49.6	29.1	1.87	56.0	26.6	1.8	1650	35.3	3.06	24.8	89.8	3.4	3.5
	9.0	2.1	4.9	1364	44.1	23.2	1.64	49.7	26.8	1.8	1450	36.2	3.16	25.7	93.1	3.4	3.5
	9.0	2.1	4.9	1550	44.9	25.0	1.70	50.7	26.3	1.9	1650	36.8	3.06	26.3	90.6	3.5	3.5
	12.0	3.8	8.8	1364	41.5	21.3	1.57	46.8	26.4	1.9	1450	37.1	3.16	26.5	93.7	3.4	3.5
	12.0	3.8	8.8	1550	42.2	22.9	1.63	47.8	25.9	1.9	1650	37.6	3.06	27.2	91.1	3.6	3.6
40	6.0	0.8	1.8	1364	53.0	31.2	2.05	59.8	25.8	1.9	1450	39.9	3.18	29.2	95.5	3.7	3.6
	6.0	0.8	1.8	1550	53.9	33.6	2.12	61.1	25.4	2.0	1650	40.5	3.08	30.0	92.7	3.8	3.7
	9.0	2.0	4.6	1364	50.7	28.8	1.89	57.1	26.8	1.8	1450	41.7	3.20	30.9	96.6	3.8	3.7
	9.0	2.0	4.6	1550	51.6	31.0	1.96	58.3	26.3	1.8	1650	42.3	3.11	31.7	93.8	4.0	3.8
	12.0	3.6	8.4	1364	49.1	27.4	1.82	55.2	27.0	1.8	1450	42.7	3.22	31.8	97.3	3.9	3.8
	12.0	3.6	8.4	1550	50.0	29.4	1.88	56.4	26.5	1.8	1650	43.3	3.12	32.7	94.3	4.1	3.9
50	6.0	0.7	1.7	1364	54.0	33.2	2.28	61.7	23.7	2.3	1450	45.0	3.26	34.0	98.8	4.0	3.9
	6.0	0.7	1.7	1550	54.9	35.7	2.37	63.0	23.2	2.3	1650	45.7	3.16	34.9	95.7	4.2	4.0
	9.0	1.9	4.3	1364	53.5	32.0	2.12	60.7	25.2	2.0	1450	47.2	3.30	36.0	100.1	4.2	4.1
	9.0	1.9	4.3	1550	54.5	34.5	2.20	62.0	24.8	2.1	1650	47.9	3.20	37.0	96.9	4.4	4.1
	12.0	3.5	8.0	1364	52.9	31.2	2.05	59.8	25.9	1.9	1450	48.3	3.33	37.1	100.9	4.3	4.1
	12.0	3.5	8.0	1550	53.8	33.5	2.12	61.1	25.4	2.0	1650	49.1	3.23	38.1	97.5	4.5	4.2
60	6.0	0.7	1.6	1364	53.1	33.6	2.52	61.6	21.1	2.9	1450	50.2	3.38	38.8	102.1	4.4	4.3
	6.0	0.7	1.6	1550	54.0	36.1	2.61	62.9	20.7	2.9	1650	51.0	3.27	39.8	98.6	4.6	4.4
	9.0	1.8	4.2	1364	53.9	33.4	2.35	61.8	22.9	2.4	1450	52.7	3.44	41.0	103.6	4.5	4.4
	9.0	1.8	4.2	1550	54.8	36.0	2.44	63.1	22.5	2.5	1650	53.5	3.33	42.1	100.0	4.7	4.5
	12.0	3.4	7.8	1364	54.0	33.1	2.27	61.6	23.8	2.3	1450	54.0	3.48	42.2	104.5	4.6	4.5
	12.0	3.4	7.8	1550	54.9	35.6	2.35	63.0	23.3	2.3	1650	54.8	3.37	43.3	100.8	4.8	4.6
70	6.0	0.7	1.5	1364	51.0	33.0	2.78	60.4	18.4	3.6	1450	55.5	3.52	43.5	105.4	4.6	4.6
	6.0	0.7	1.5	1550	51.9	35.5	2.88	61.7	18.0	3.7	1650	56.3	3.41	44.7	101.6	4.8	4.7
	9.0	1.8	4.0	1364	52.6	33.5	2.60	61.3	20.2	3.1	1450	58.2	3.60	46.0	107.2	4.7	4.9
	9.0	1.8	4.0	1550	53.5	36.0	2.69	62.7	19.9	3.1	1650	59.1	3.49	47.2	103.2	5.0	5.0
	12.0	3.3	7.6	1364	53.2	33.6	2.51	61.6	21.2	2.8	1450	59.7	3.65	47.3	108.1	4.8	5.0
	12.0	3.3	7.6	1550	54.1	36.1	2.60	63.0	20.8	2.9	1650	60.6	3.53	48.6	104.0	5.0	5.1
80	6.0	0.7	1.5	1364	48.1	31.8	3.07	58.6	15.7	4.5	1450	60.7	3.68	48.2	108.8	4.8	5.1
	6.0	0.7	1.5	1550	49.0	34.2	3.18	59.8	15.4	4.6	1650	61.6	3.56	49.5	104.6	5.1	5.2
	9.0	1.7	4.0	1364	50.1	32.7	2.87	59.9	17.5	3.8	1450	63.8	3.77	50.9	110.7	5.0	5.4
	9.0	1.7	4.0	1550	51.0	35.1	2.97	61.1	17.2	3.9	1650	64.8	3.65	52.3	106.3	5.2	5.5
	12.0	3.2	7.5	1364	51.1	33.0	2.77	60.4	18.4	3.6	1450	65.5	3.82	52.4	111.8	5.0	5.9
	12.0	3.2	7.5	1550	51.9	35.5	2.87	61.7	18.1	3.6	1650	66.5	3.70	53.8	107.3	5.3	6.0
85	6.0	0.7	1.5	1364	46.5	31.0	3.2	57.5	14.5	5.0	1450	63.4	3.76	50.6	110.5	4.9	5.3
	6.0	0.7	1.5	1550	47.3	33.3	3.35	58.8	14.2	5.1	1650	64.3	3.6	51.9	106.1	5.2	5.4
	9.0	1.7	3.9	1364	48.6	32.0	3.02	58.9	16.2	4.3	1450	66.6	3.8	53.5	112.5	5.1	5.6
	9.0	1.7	3.9	1550	49.4	34.4	3.13	60.1	15.9	4.4	1650	67.6	3.7	54.9	108.0	5.3	5.8
	12.0	3.2	7.4	1364	49.6	32.4	2.92	59.5	17.1	4.0	1450	68.4	3.9	55.1	113.7	5.1	6.0
	12.0	3.2	7.4	1550	50.5	34.8	3.02	60.8	16.8	4.1	1650	69.4	3.8	56.5	109.0	5.4	6.1
90	6.0	0.7	1.5	1364	44.9	30.2	3.39	56.5	13.2	5.5	1450	66.0	3.83	52.9	112.2	5.0	5.6
	6.0	0.7	1.5	1550	45.7	32.5	3.52	57.7	13.0	5.6	1650	67.0	3.72	54.3	107.6	5.3	5.7
	9.0	1.7	3.9	1364	47.1	31.3	3.17	57.9	14.8	4.8	1450	69.4	3.93	56.0	114.3	5.2	5.9
	9.0	1.7	3.9	1550	47.9	33.6	3.29	59.1	14.6	4.9	1650	70.5	3.81	57.5	109.6	5.4	6.0
	12.0	3.2	7.4	1364	48.1	31.8	3.07	58.5	15.7	4.5	1450	71.3	3.98	57.7	115.5	5.3	6.1
	12.0	3.2	7.4	1550	49.0	34.2	3.18	59.8	15.4	4.6	1650	72.4	3.86	59.2	110.6	5.5	6.2
100	6.0	0.6	1.5	1364	41.7	28.6	3.78	54.6	11.1	6.8							
	6.0	0.6	1.5	1550	42.5	30.8	3.91	55.8	10.8	6.9							
	9.0	1.7	3.8	1364	43.7	29.6	3.53	55.8	12.4	6.0							
	9.0	1.7	3.8	1550	44.5	31.8	3.65	57.0	12.2	6.1							
	12.0	3.2	7.3	1364	44.8	30.1	3.41	56.4	13.2	5.6							
	12.0	3.2	7.3	1550	45.6	32.4	3.53	57.6	12.9	5.7							
110	6.0	0.6	1.4	1364	38.9	27.3	4.23	53.4	9.2	8.2							
	6.0	0.6	1.4	1550	39.5	29.3	4.38	54.5	9.0	8.4							
	9.0	1.6	3.7	1364	40.6	28.0	3.94	54.0	10.3	7.3							
	9.0	1.6	3.7	1550	41.3	30.2	4.09	55.2	10.1	7.4							
	12.0	3.1	7.2	1364	41.5	28.5	3.81	54.5	10.9	6.9							
	12.0	3.1	7.2	1550	42.2	30.6	3.94	55.7	10.7	7.0							
120	6.0	0.6	1.3	1364	36.8	26.6	4.78	53.2	7.7	9.9							
	6.0	0.6	1.3	1550	37.4	28.6	4.96	54.3	7.6	10.1							
	9.0	1.6	3.6	1364	37.9	26.9	4.44	53.1	8.5	8.8							
	9.0	1.6	3.6	1550	38.6	28.9	4.60	54.3	8.4	9.0							
	12.0	3.0	7.0	1364	38.6	27.2	4.28	53.3	9.0	8.3							
	12.0	3.0	7.0	1550	39.3	29.2	4.43	54.4	8.9	8.5							

Interpolation is permissible, extrapolation is not. All performance data is based on the lower voltage of dual voltage units. Performance stated is at the rated power supply, performance may vary as the power supply varies from the rated. Table is with entering air of 80°F DB and 67°F WB in cooling, and 70°F DB in heating. AHRI/ISO certified conditions are 80.6°F DB and 66.2°F WB in cooling and 68°F DB in heating. Table does not reflect fan or pump power corrections for AHRI/ISO conditions. See performance correction tables for operating conditions other than those listed above. See performance data selection notes for operation in the shaded areas. Operation below 40°F EWT is based on a 15% methanol antifreeze solution. Operation below 60°F EWT requires optional extended range insulated water and refrigerant circuits to avoid condensation within the unit cabinet.



# Performance Data - HZ H/V/D 060 (Part Load), No vFlow®

1650 CFM Nominal (Rated) Airflow Heating, 1500 CFM Nominal (Rated) Airflow Cooling

Performance capacities shown in thousands of Btu/h

EWT °F	GPM	WPD		COOLING - EAT 80/67 °F							HEATING - 70°F						
		PSI	FT	CFM	TC	SC	kW	HR	EER	HWC	CFM	HC	kW	HE	LAT	COP	HWC
20	12.0	5.2	11.9								1450	28.2	2.87	18.7	88.0	2.9	3.1
	12.0	5.2	11.9								1650	28.6	2.75	19.3	86.1	3.1	3.1
30	6.0	0.9	2.1	1320	56.0	38.9	1.47	61.1	38.0	1.0	1450	31.7	2.88	22.1	90.2	3.2	3.1
	6.0	0.9	2.1	1500	57.1	41.6	1.50	62.2	38.1	1.1	1650	32.2	2.76	22.7	88.0	3.4	3.2
	9.0	2.5	5.7	1320	55.8	39.5	1.42	60.6	39.2	1.0	1450	33.1	2.89	23.5	91.1	3.4	3.2
	9.0	2.5	5.7	1500	56.9	42.3	1.45	61.8	39.2	1.0	1650	33.6	2.77	24.1	88.8	3.6	3.2
	12.0	4.2	9.6	1320	55.4	39.8	1.41	60.2	39.2	1.0	1450	33.9	2.89	24.2	91.6	3.4	3.2
	12.0	4.2	9.6	1500	56.5	42.6	1.44	61.4	39.2	1.0	1650	34.4	2.77	24.9	89.3	3.6	3.2
40	6.0	0.5	1.1	1320	55.3	38.0	1.61	60.8	34.4	1.3	1450	37.0	2.91	27.3	93.6	3.7	3.2
	6.0	0.5	1.1	1500	56.4	40.7	1.64	62.0	34.4	1.3	1650	37.6	2.79	28.0	91.1	3.9	3.3
	9.0	1.9	4.4	1320	55.9	38.6	1.51	61.1	37.0	1.1	1450	38.8	2.92	29.0	94.8	3.9	3.3
	9.0	1.9	4.4	1500	57.0	41.3	1.54	62.3	37.0	1.1	1650	39.4	2.80	29.8	92.1	4.1	3.4
	12.0	3.4	7.9	1320	56.0	38.9	1.47	61.0	38.0	1.0	1450	39.8	2.93	30.0	95.4	4.0	3.3
	12.0	3.4	7.9	1500	57.1	41.7	1.50	62.2	38.1	1.1	1650	40.4	2.81	30.8	92.7	4.2	3.4
50	6.0	0.2	0.6	1320	53.7	37.2	1.82	59.9	29.6	1.8	1450	42.5	2.94	32.6	97.1	4.2	3.4
	6.0	0.2	0.6	1500	54.8	39.8	1.85	61.1	29.6	1.8	1650	43.1	2.82	33.5	94.2	4.5	3.5
	9.0	1.5	3.5	1320	54.9	37.8	1.67	60.6	32.9	1.4	1450	44.7	2.96	34.7	98.5	4.4	3.5
	9.0	1.5	3.5	1500	56.0	40.4	1.70	61.8	32.9	1.5	1650	45.3	2.84	35.7	95.4	4.7	3.5
	12.0	3.0	6.9	1320	55.4	38.1	1.60	60.9	34.6	1.3	1450	45.9	2.97	35.9	99.3	4.5	3.5
	12.0	3.0	6.9	1500	56.5	40.8	1.63	62.0	34.6	1.3	1650	46.6	2.85	36.9	96.1	4.8	3.6
60	6.0	0.2	0.4	1320	51.4	36.3	2.07	58.5	24.8	2.4	1450	48.1	2.98	37.9	100.7	4.7	3.6
	6.0	0.2	0.4	1500	52.4	38.9	2.11	59.6	24.8	2.5	1650	48.8	2.86	39.0	97.4	5.0	3.7
	9.0	1.4	3.2	1320	53.0	36.9	1.90	59.5	28.0	2.0	1450	50.6	3.01	40.4	102.3	4.9	3.7
	9.0	1.4	3.2	1500	54.1	39.5	1.93	60.6	28.0	2.0	1650	51.4	2.89	41.5	98.8	5.2	3.8
	12.0	2.7	6.3	1320	53.8	37.2	1.81	59.9	29.8	1.8	1450	52.1	3.02	41.7	103.2	5.0	3.8
	12.0	2.7	6.3	1500	54.8	39.9	1.84	61.1	29.8	1.8	1650	52.8	2.90	42.9	99.6	5.3	3.8
70	6.0	0.2	0.4	1320	48.6	35.4	2.38	56.7	20.5	3.3	1450	53.6	3.04	43.3	104.2	5.2	3.8
	6.0	0.2	0.4	1500	49.6	37.9	2.42	57.8	20.5	3.3	1650	54.4	2.91	44.5	100.5	5.5	3.9
	9.0	1.3	3.0	1320	50.5	36.0	2.17	57.9	23.3	2.7	1450	56.5	3.07	46.0	106.1	5.4	4.0
	9.0	1.3	3.0	1500	51.5	38.6	2.21	59.0	23.3	2.7	1650	57.3	2.94	47.3	102.2	5.7	4.1
	12.0	2.6	6.0	1320	51.4	36.3	2.07	58.5	24.8	2.4	1450	58.1	3.09	47.5	107.1	5.5	4.1
	12.0	2.6	6.0	1500	52.4	38.9	2.11	59.6	24.8	2.5	1650	58.9	2.96	48.8	103.1	5.8	4.2
80	6.0	0.3	0.6	1320	45.6	34.3	2.73	54.9	16.7	4.3	1450	59.1	3.10	48.5	107.7	5.6	4.1
	6.0	0.3	0.6	1500	46.5	36.7	2.78	56.0	16.7	4.4	1650	59.9	2.97	49.8	103.6	5.9	4.2
	9.0	1.3	3.1	1320	47.5	35.0	2.50	56.1	19.0	3.6	1450	62.2	3.13	51.5	109.7	5.8	4.3
	9.0	1.3	3.1	1500	48.5	37.5	2.55	57.2	19.0	3.7	1650	63.1	3.00	52.9	105.4	6.2	4.4
	12.0	2.6	5.9	1320	48.5	35.3	2.40	56.7	20.2	3.3	1450	63.9	3.16	53.0	110.8	5.9	4.4
	12.0	2.6	5.9	1500	49.5	37.8	2.44	57.8	20.3	3.4	1650	64.8	3.03	54.5	106.4	6.3	4.5
85	6.0	0.3	0.7	1320	44.0	33.6	2.9	54.0	15.1	4.9	1450	61.8	3.13	51.0	109.4	5.8	4.3
	6.0	0.3	0.7	1500	44.9	36.0	2.98	55.0	15.2	5.0	1650	62.6	3.0	52.4	105.1	6.1	4.4
	9.0	1.4	3.2	1320	46.0	34.4	2.69	55.1	17.2	4.2	1450	65.0	3.2	54.0	111.5	6.0	4.5
	9.0	1.4	3.2	1500	46.8	36.8	2.74	56.2	17.2	4.2	1650	65.9	3.0	55.5	107.0	6.4	4.6
	12.0	2.6	5.9	1320	46.9	34.8	2.58	55.7	18.3	3.8	1450	66.7	3.2	55.6	112.6	6.1	4.6
	12.0	2.6	5.9	1500	47.9	37.2	2.63	56.8	18.4	3.9	1650	67.6	3.1	57.2	108.0	6.5	4.7
90	6.0	0.3	0.7	1320	42.4	33.0	3.12	53.1	13.6	5.5	1450	64.4	3.16	53.5	111.1	6.0	4.5
	6.0	0.3	0.7	1500	43.3	35.3	3.18	54.1	13.6	5.6	1650	65.3	3.03	55.0	106.7	6.3	4.6
	9.0	1.4	3.2	1320	44.4	33.8	2.88	54.2	15.4	4.7	1450	67.7	3.21	56.6	113.2	6.2	4.7
	9.0	1.4	3.2	1500	45.2	36.2	2.93	55.2	15.4	4.8	1650	68.7	3.08	58.2	108.5	6.5	4.8
	12.0	2.6	6.0	1320	45.4	34.2	2.76	54.8	16.4	4.4	1450	69.4	3.24	58.2	114.3	6.3	4.9
	12.0	2.6	6.0	1500	46.2	36.6	2.81	55.8	16.5	4.4	1650	70.4	3.11	59.8	109.5	6.6	4.9
100	6.0	0.3	0.8	1320	39.4	31.6	3.55	51.5	11.1	6.9							
	6.0	0.3	0.8	1500	40.2	33.9	3.62	52.5	11.1	7.0							
	9.0	1.4	3.2	1320	41.2	32.4	3.30	52.4	12.5	6.0							
	9.0	1.4	3.2	1500	42.0	34.7	3.36	53.4	12.5	6.1							
	12.0	2.6	6.0	1320	42.1	32.9	3.17	52.9	13.3	5.6							
	12.0	2.6	6.0	1500	43.0	35.2	3.23	54.0	13.3	5.7							
110	6.0	0.3	0.6	1320	36.7	30.2	4.02	50.4	9.1	8.5							
	6.0	0.3	0.6	1500	37.4	32.4	4.09	51.3	9.1	8.7							
	9.0	1.3	3.1	1320	38.2	31.0	3.74	51.0	10.2	7.5							
	9.0	1.3	3.1	1500	38.9	33.2	3.81	52.0	10.2	7.7							
	12.0	2.5	5.8	1320	39.0	31.4	3.61	51.4	10.8	7.1							
	12.0	2.5	5.8	1500	39.8	33.7	3.68	52.3	10.8	7.2							
120	6.0	0.0	0.0	1320	34.4	28.9	4.51	49.8	7.6	10.3							
	6.0	0.0	0.0	1500	35.1	31.0	4.59	50.8	7.6	10.5							
	9.0	1.1	2.6	1320	35.6	29.6	4.22	50.0	8.4	9.3							
	9.0	1.1	2.6	1500	36.3	31.7	4.30	51.0	8.4	9.4							
	12.0	2.4	5.4	1320	36.3	30.0	4.09	50.2	8.9	8.7							
	12.0	2.4	5.4	1500	37.0	32.2	4.16	51.2	8.9	8.9							

Interpolation is permissible, extrapolation is not. All performance data is based on the lower voltage of dual voltage units.

Performance stated is at the rated power supply, performance may vary as the power supply varies from the rated.

Table is with entering air of 80°F DB and 67°F WB in cooling, and 70°F DB in heating.

AHRI/ISO certified conditions are 80.6°F DB and 66.2°F WB in cooling and 68°F DB in heating.

Table does not reflect fan or pump power corrections for AHRI/ISO conditions.

See performance correction tables for operating conditions other than those listed above. See performance data selection notes for operation in the shaded areas.

Operation below 40°F EWT is based on a 15% methanol antifreeze solution.

Operation below 60°F EWT requires optional extended range insulated water and refrigerant circuits to avoid condensation within the unit cabinet.

# Performance Data - HZ H/V/D 060 (Full Load), No vFlow<sup>®</sup>

## 2050 CFM Nominal (Rated) Airflow Heating, 1850 CFM Nominal (Rated) Airflow Cooling

Performance capacities shown in thousands of Btu/h

EWT °F	GPM	WPD		COOLING - EAT 80/67 °F							HEATING - 70°F						
		PSI	FT	CFM	TC	SC	kW	HR	EER	HWC	CFM	HC	kW	HE	LAT	COP	HWC
20	15.0	7.3	16.8								1800	42.8	3.89	29.8	92.0	3.2	3.8
	15.0	7.3	16.8								2050	43.5	3.77	30.6	89.6	3.4	3.8
30	7.5	1.7	3.9	1630	75.3	49.7	2.68	84.3	28.1	1.9	1800	46.9	3.94	33.6	94.1	3.5	3.9
	7.5	1.7	3.9	1850	76.6	53.4	2.78	86.1	27.5	2.0	2050	47.6	3.82	34.5	91.5	3.7	4.0
	11.3	3.7	8.6	1630	74.9	50.3	2.58	83.5	29.1	1.8	1800	49.1	3.98	35.8	95.3	3.6	4.0
	11.3	3.7	8.6	1850	76.2	54.0	2.67	85.3	28.5	1.8	2050	49.9	3.86	36.7	92.5	3.8	4.1
	15.0	6.1	14.1	1630	74.2	50.5	2.53	82.7	29.4	1.8	1800	50.4	4.00	36.9	95.9	3.7	4.0
	15.0	6.1	14.1	1850	75.5	54.3	2.62	84.5	28.8	1.8	2050	51.2	3.88	37.9	93.1	3.9	4.1
40	7.5	1.2	2.7	1630	74.4	48.8	2.87	84.0	26.0	2.3	1800	53.9	4.07	40.2	97.7	3.9	4.2
	7.5	1.2	2.7	1850	75.7	52.5	2.97	85.8	25.5	2.3	2050	54.7	3.94	41.3	94.7	4.1	4.2
	11.3	3.0	7.0	1630	75.2	49.5	2.72	84.3	27.6	2.0	1800	56.7	4.12	42.8	99.2	4.0	4.3
	11.3	3.0	7.0	1850	76.5	53.2	2.82	86.1	27.1	2.1	2050	57.6	3.99	44.0	96.0	4.2	4.4
	15.0	5.3	12.2	1630	75.3	49.8	2.66	84.2	28.3	1.9	1800	58.3	4.15	44.3	100.0	4.1	4.3
	15.0	5.3	12.2	1850	76.6	53.6	2.76	86.0	27.7	1.9	2050	59.2	4.02	45.5	96.7	4.3	4.4
50	7.5	0.9	2.0	1630	72.4	47.8	3.09	82.8	23.4	2.8	1800	61.1	4.21	46.9	101.5	4.3	4.5
	7.5	0.9	2.0	1850	73.6	51.4	3.20	84.5	23.0	2.9	2050	62.1	4.08	48.2	98.0	4.5	4.6
	11.3	2.6	6.0	1630	74.0	48.6	2.91	83.8	25.4	2.4	1800	64.5	4.28	50.0	103.2	4.4	4.6
	11.3	2.6	6.0	1850	75.3	52.2	3.02	85.6	24.9	2.5	2050	65.5	4.15	51.3	99.6	4.6	4.7
	15.0	4.7	10.8	1630	74.6	48.9	2.84	84.1	26.3	2.2	1800	66.3	4.32	51.7	104.1	4.5	4.7
	15.0	4.7	10.8	1850	75.9	52.6	2.94	85.9	25.8	2.3	2050	67.3	4.19	53.0	100.4	4.7	4.8
60	7.5	0.8	1.7	1630	69.5	46.7	3.35	80.9	20.8	3.5	1800	68.5	4.38	53.6	105.2	4.6	4.9
	7.5	0.8	1.7	1850	70.7	50.3	3.47	82.6	20.4	3.6	2050	69.5	4.24	55.1	101.4	4.8	5.0
	11.3	2.4	5.4	1630	71.7	47.6	3.15	82.3	22.8	3.0	1800	72.3	4.47	57.1	107.2	4.7	5.1
	11.3	2.4	5.4	1850	73.0	51.1	3.26	84.1	22.4	3.1	2050	73.4	4.33	58.6	103.2	5.0	5.2
	15.0	4.3	10.0	1630	72.7	48.0	3.05	83.0	23.8	2.8	1800	74.4	4.52	59.0	108.3	4.8	5.2
	15.0	4.3	10.0	1850	74.0	51.6	3.16	84.8	23.4	2.8	2050	75.5	4.38	60.6	104.1	5.1	5.3
70	7.5	0.7	1.7	1630	66.1	45.5	3.68	78.6	18.0	4.4	1800	75.8	4.55	60.3	109.0	4.9	5.3
	7.5	0.7	1.7	1850	67.3	48.9	3.81	80.3	17.7	4.5	2050	77.0	4.41	61.9	104.8	5.1	5.4
	11.3	2.3	5.2	1630	68.6	46.4	3.44	80.3	20.0	3.8	1800	80.1	4.66	64.2	111.2	5.0	5.6
	11.3	2.3	5.2	1850	69.8	49.9	3.56	82.0	19.6	3.8	2050	81.3	4.52	65.9	106.7	5.3	5.7
	15.0	4.1	9.6	1630	69.9	46.9	3.32	81.1	21.0	3.5	1800	82.4	4.74	66.3	112.4	5.1	5.7
	15.0	4.1	9.6	1850	71.1	50.4	3.44	82.8	20.7	3.5	2050	83.7	4.59	68.0	107.8	5.3	5.8
80	7.5	0.8	1.8	1630	62.5	44.1	4.04	76.2	15.4	5.5	1800	83.1	4.76	66.9	112.8	5.1	5.8
	7.5	0.8	1.8	1850	63.5	47.5	4.19	77.8	15.2	5.6	2050	84.4	4.61	68.7	108.1	5.4	5.9
	11.3	2.2	5.2	1630	65.1	45.1	3.77	77.9	17.2	4.7	1800	87.8	4.89	71.1	115.2	5.3	6.1
	11.3	2.2	5.2	1850	66.2	48.5	3.91	79.6	16.9	4.8	2050	89.1	4.74	73.0	110.3	5.5	6.2
	15.0	4.1	9.4	1630	66.4	45.6	3.65	78.7	18.2	4.3	1800	90.3	4.96	73.3	116.5	5.3	6.7
	15.0	4.1	9.4	1850	67.5	49.0	3.78	80.4	17.9	4.4	2050	91.7	4.81	75.3	111.4	5.6	6.9
85	7.5	0.6	1.3	1630	60.6	43.4	4.3	75.1	14.3	6.1	1800	86.7	4.86	70.1	114.6	5.2	6.0
	7.5	0.6	1.3	1850	61.6	46.7	4.42	76.7	14.0	6.2	2050	88.0	4.7	72.0	109.8	5.5	6.2
	11.3	1.8	4.2	1630	63.2	44.4	3.98	76.7	16.0	5.3	1800	91.5	5.0	74.4	117.1	5.4	6.4
	11.3	1.8	4.2	1850	64.3	47.7	4.12	78.3	15.7	5.4	2050	92.9	4.9	76.3	112.0	5.6	6.5
	15.0	3.3	7.7	1630	64.5	44.9	3.84	77.5	16.9	4.9	1800	94.1	5.1	76.7	118.4	5.4	6.8
	15.0	3.3	7.7	1850	65.6	48.3	3.98	79.2	16.6	5.0	2050	95.5	4.9	78.7	113.1	5.7	7.0
90	7.5	0.3	0.7	1630	58.7	42.6	4.49	74.0	13.1	6.7	1800	90.3	4.96	73.3	116.4	5.3	6.3
	7.5	0.3	0.7	1850	59.8	45.8	4.65	75.6	12.8	6.8	2050	91.7	4.81	75.2	111.4	5.6	6.4
	11.3	1.4	3.2	1630	61.3	43.7	4.18	75.5	14.7	5.8	1800	95.2	5.12	77.7	119.0	5.5	6.7
	11.3	1.4	3.2	1850	62.3	47.0	4.33	77.1	14.4	6.0	2050	96.7	4.96	79.7	113.7	5.7	6.9
	15.0	2.6	6.0	1630	62.6	44.2	4.03	76.3	15.5	5.4	1800	97.9	5.21	80.0	120.3	5.5	7.0
	15.0	2.6	6.0	1850	63.7	47.5	4.18	77.9	15.2	5.5	2050	99.4	5.05	82.1	114.9	5.8	7.1
100	7.5	0.3	0.8	1630	55.2	41.1	5.00	72.3	11.0	8.1							
	7.5	0.3	0.8	1850	56.2	44.2	5.18	73.9	10.8	8.3							
	11.3	1.4	3.2	1630	57.5	42.1	4.65	73.4	12.4	7.2							
	11.3	1.4	3.2	1850	58.5	45.3	4.82	75.0	12.1	7.3							
	15.0	2.6	6.0	1630	58.8	42.6	4.49	74.0	13.1	6.7							
	15.0	2.6	6.0	1850	59.8	45.9	4.65	75.6	12.9	6.8							
110	7.5	0.3	0.6	1630	52.2	39.6	5.60	71.4	9.3	9.8							
	7.5	0.3	0.6	1850	53.1	42.6	5.80	72.9	9.2	10.0							
	11.3	1.3	3.1	1630	54.1	40.6	5.20	71.9	10.4	8.7							
	11.3	1.3	3.1	1850	55.0	43.6	5.39	73.4	10.2	8.9							
	15.0	2.5	5.8	1630	55.2	41.1	5.01	72.3	11.0	8.2							
	15.0	2.5	5.8	1850	56.1	44.2	5.19	73.8	10.8	8.3							
120	7.5	0.0	0.0	1630	50.0	38.5	6.30	71.6	7.9	11.7							
	7.5	0.0	0.0	1850	50.8	41.4	6.53	73.1	7.8	11.9							
	11.3	1.1	2.6	1630	51.3	39.2	5.83	71.3	8.8	10.4							
	11.3	1.1	2.6	1850	52.2	42.1	6.04	72.8	8.6	10.6							
	15.0	2.4	5.4	1630	52.1	39.6	5.62	71.3	9.3	9.8							
	15.0	2.4	5.4	1850	53.0	42.6	5.82	72.9	9.1	10.0							

Interpolation is permissible, extrapolation is not. All performance data is based on the lower voltage of dual voltage units.

Performance stated is at the rated power supply, performance may vary as the power supply varies from the rated.

Table is with entering air of 80°F DB and 67°F WB in cooling, and 70°F DB in heating.

AHRI/ISO certified conditions are 80.6°F DB and 66.2°F WB in cooling and 68°F DB in heating.

Table does not reflect fan or pump power corrections for AHRI/ISO conditions.

See performance correction tables for operating conditions other than those listed above. See performance data selection notes for operation in the shaded areas.

Operation below 40°F EWT is based on a 15% methanol antifreeze solution.

Operation below 60°F EWT requires optional extended range insulated water and refrigerant circuits to avoid condensation within the unit cabinet.



# Performance Data - HZ H/V/D 070 (Part Load), No vFlow®

## 1650 CFM Nominal (Rated) Airflow Heating, 1550 CFM Nominal (Rated) Airflow Cooling

Performance capacities shown in thousands of Btuh

EWT °F	GPM	WPD		COOLING - EAT 80/67 °F							HEATING - 70°F						
		PSI	FT	CFM	TC	SC	kW	HR	EER	HWC	CFM	HC	kW	HE	LAT	COP	HWC
20	14.0	6.5	15.1								1450	32.9	3.66	20.9	91.0	2.6	4.1
	14.0	6.5	15.1								1650	33.4	3.51	21.4	88.7	2.8	4.1
30	7.0	1.4	3.3	1360	65.1	40.9	1.82	71.3	35.8	2.2	1450	37.2	3.72	24.8	93.7	2.9	4.2
	7.0	1.4	3.3	1550	66.4	43.8	1.85	72.7	35.9	2.2	1650	37.7	3.57	25.5	91.1	3.1	4.3
	10.5	3.3	7.6	1360	65.5	41.3	1.72	71.3	38.1	2.2	1450	38.7	3.74	26.3	94.7	3.0	4.2
	10.5	3.3	7.6	1550	66.7	44.2	1.75	72.7	38.1	2.2	1650	39.3	3.59	27.0	92.0	3.2	4.3
	14.0	5.4	12.5	1360	65.5	41.4	1.68	71.2	39.0	2.2	1450	39.6	3.75	27.1	95.3	3.1	4.2
	14.0	5.4	12.5	1550	66.7	44.4	1.71	72.6	39.0	2.3	1650	40.1	3.60	27.8	92.5	3.3	4.3
40	7.0	0.9	2.2	1360	63.8	40.1	2.01	70.7	31.7	2.3	1450	43.3	3.81	30.6	97.6	3.3	4.4
	7.0	0.9	2.2	1550	65.0	43.0	2.05	72.0	31.7	2.4	1650	43.9	3.65	31.4	94.6	3.5	4.5
	10.5	2.6	6.1	1360	64.8	40.7	1.88	71.2	34.5	2.2	1450	45.2	3.84	32.4	98.9	3.5	4.4
	10.5	2.6	6.1	1550	66.0	43.6	1.91	72.5	34.6	2.2	1650	45.8	3.68	33.3	95.7	3.7	4.5
	14.0	4.6	10.7	1360	65.1	40.9	1.81	71.3	36.0	2.2	1450	46.3	3.85	33.4	99.5	3.5	4.4
	14.0	4.6	10.7	1550	66.4	43.8	1.84	72.7	36.1	2.2	1650	46.9	3.69	34.3	96.3	3.7	4.5
50	7.0	0.7	1.5	1360	61.7	39.2	2.28	69.5	27.1	2.6	1450	49.4	3.90	36.3	101.5	3.7	4.7
	7.0	0.7	1.5	1550	62.9	41.9	2.32	70.8	27.1	2.7	1650	50.1	3.74	37.4	98.1	3.9	4.8
	10.5	2.2	5.1	1360	63.2	39.8	2.09	70.3	30.2	2.4	1450	51.7	3.93	38.5	103.0	3.9	4.8
	10.5	2.2	5.1	1550	64.4	42.7	2.13	71.7	30.3	2.5	1650	52.5	3.77	39.6	99.4	4.1	4.9
	14.0	4.1	9.4	1360	63.8	40.2	2.01	70.7	31.7	2.4	1450	53.0	3.94	39.7	103.8	3.9	4.8
	14.0	4.1	9.4	1550	65.1	43.0	2.05	72.1	31.7	2.5	1650	53.8	3.78	40.8	100.2	4.2	4.9
60	7.0	0.5	1.3	1360	59.1	38.1	2.60	68.0	22.7	3.2	1450	55.6	3.98	42.2	105.5	4.1	5.1
	7.0	0.5	1.3	1550	60.2	40.8	2.65	69.3	22.7	3.2	1650	56.4	3.82	43.3	101.6	4.3	5.2
	10.5	2.0	4.6	1360	60.9	38.8	2.38	69.0	25.6	2.8	1450	58.3	4.03	44.7	107.2	4.2	5.2
	10.5	2.0	4.6	1550	62.1	41.6	2.42	70.4	25.7	2.9	1650	59.1	3.86	46.0	103.2	4.5	5.3
	14.0	3.8	8.7	1360	61.8	39.2	2.28	69.5	27.1	2.7	1450	59.8	4.05	46.1	108.2	4.3	5.3
	14.0	3.8	8.7	1550	63.0	42.0	2.32	70.9	27.1	2.7	1650	60.6	3.88	47.4	104.0	4.6	5.4
70	7.0	0.5	1.3	1360	56.0	36.9	2.99	66.2	18.8	4.2	1450	61.8	4.07	48.0	109.4	4.4	5.5
	7.0	0.5	1.3	1550	57.1	39.5	3.04	67.5	18.8	4.3	1650	62.6	3.90	49.3	105.1	4.7	5.6
	10.5	1.9	4.5	1360	58.1	37.7	2.73	67.4	21.3	3.6	1450	64.8	4.12	50.9	111.4	4.6	5.7
	10.5	1.9	4.5	1550	59.2	40.3	2.78	68.7	21.3	3.7	1650	65.8	3.95	52.3	106.9	4.9	5.8
	14.0	3.6	8.3	1360	59.1	38.1	2.60	67.9	22.7	3.4	1450	66.5	4.14	52.5	112.5	4.7	5.8
	14.0	3.6	8.3	1550	60.2	40.7	2.65	69.3	22.7	3.5	1650	67.5	3.97	53.9	107.9	5.0	5.9
80	7.0	0.6	1.4	1360	52.7	35.6	3.42	64.3	15.4	5.7	1450	68.0	4.16	53.8	113.4	4.8	6.0
	7.0	0.6	1.4	1550	53.7	38.1	3.48	65.6	15.4	5.8	1650	68.9	3.99	55.3	108.7	5.1	6.1
	10.5	1.9	4.5	1360	54.8	36.4	3.13	65.5	17.5	4.9	1450	71.4	4.22	57.0	115.6	5.0	6.2
	10.5	1.9	4.5	1550	55.9	39.0	3.19	66.8	17.5	5.0	1650	72.4	4.05	58.6	110.6	5.2	6.3
	14.0	3.5	8.1	1360	55.9	36.8	3.00	66.1	18.7	4.5	1450	73.3	4.26	58.8	116.8	5.0	6.4
	14.0	3.5	8.1	1550	57.0	39.4	3.05	67.4	18.7	4.6	1650	74.3	4.08	60.4	111.7	5.3	6.5
85	7.0	0.6	1.5	1360	50.9	34.9	3.7	63.4	14.0	6.6	1450	71.1	4.21	56.7	115.4	4.9	6.2
	7.0	0.6	1.5	1550	51.9	37.4	3.73	64.6	14.0	6.7	1650	72.1	4.0	58.3	110.4	5.2	6.4
	10.5	1.9	4.5	1360	53.1	35.7	3.37	64.6	15.9	5.7	1450	74.7	4.3	60.1	117.7	5.1	6.5
	10.5	1.9	4.5	1550	54.1	38.2	3.43	65.8	15.9	5.8	1650	75.8	4.1	61.8	112.5	5.4	6.6
	14.0	3.5	8.1	1360	54.2	36.1	3.22	65.2	16.9	5.3	1450	76.7	4.3	61.9	119.0	5.2	6.7
	14.0	3.5	8.1	1550	55.2	38.7	3.28	66.4	17.0	5.4	1650	77.8	4.1	63.7	113.6	5.5	6.8
90	7.0	0.7	1.5	1360	49.1	34.2	3.91	62.5	12.6	7.5	1450	74.1	4.27	59.6	117.3	5.1	6.5
	7.0	0.7	1.5	1550	50.1	36.6	3.98	63.7	12.6	7.6	1650	75.2	4.09	61.2	112.2	5.4	6.6
	10.5	2.0	4.5	1360	51.3	35.0	3.60	63.6	14.2	6.5	1450	78.0	4.33	63.2	119.8	5.3	6.8
	10.5	2.0	4.5	1550	52.3	37.5	3.67	64.8	14.3	6.7	1650	79.1	4.15	64.9	114.4	5.6	7.0
	14.0	3.5	8.1	1360	52.4	35.5	3.45	64.2	15.2	6.1	1450	80.1	4.37	65.1	121.1	5.4	7.0
	14.0	3.5	8.1	1550	53.5	38.0	3.51	65.4	15.2	6.2	1650	81.2	4.19	66.9	115.6	5.7	7.1
100	7.0	0.7	1.6	1360	45.5	32.9	4.46	60.7	10.2	9.7							
	7.0	0.7	1.6	1550	46.4	35.2	4.54	61.9	10.2	9.9							
	10.5	2.0	4.5	1360	47.7	33.7	4.12	61.7	11.6	8.6							
	10.5	2.0	4.5	1550	48.6	36.0	4.20	62.9	11.6	8.8							
	14.0	3.5	8.1	1360	48.8	34.1	3.96	62.3	12.3	8.1							
	14.0	3.5	8.1	1550	49.7	36.5	4.03	63.5	12.3	8.2							
110	7.0	0.6	1.4	1360	42.0	31.5	5.06	59.3	8.3	12.4							
	7.0	0.6	1.4	1550	42.9	33.8	5.15	60.4	8.3	12.6							
	10.5	1.9	4.4	1360	44.1	32.3	4.69	60.1	9.4	11.1							
	10.5	1.9	4.4	1550	44.9	34.6	4.78	61.2	9.4	11.3							
	14.0	3.5	8.0	1360	45.1	32.7	4.53	60.5	10.0	10.5							
	14.0	3.5	8.0	1550	46.0	35.0	4.61	61.7	10.0	10.7							
120	7.0	0.4	0.9	1360	38.7	30.3	5.72	58.2	6.8	15.4							
	7.0	0.4	0.9	1550	39.5	32.5	5.82	59.4	6.8	15.7							
	10.5	1.7	3.9	1360	40.6	31.0	5.33	58.8	7.6	14.0							
	10.5	1.7	3.9	1550	41.4	33.2	5.43	59.9	7.6	14.3							
	14.0	3.3	7.6	1360	41.6	31.3	5.15	59.1	8.1	13.3							
	14.0	3.3	7.6	1550	42.4	33.6	5.24	60.2	8.1	13.6							

Interpolation is permissible, extrapolation is not. All performance data is based on the lower voltage of dual voltage units.  
Performance stated is at the rated power supply, performance may vary as the power supply varies from the rated.  
Table is with entering air of 80°F DB and 67°F WB in cooling, and 70°F DB in heating.  
AHRI/ISO certified conditions are 80.6°F DB and 66.2°F WB in cooling and 68°F DB in heating.  
Table does not reflect fan or pump power corrections for AHRI/ISO conditions.  
See performance correction tables for operating conditions other than those listed above. See performance data selection notes for operation in the shaded areas.  
Operation below 40°F EWT is based on a 15% methanol antifreeze solution.  
Operation below 60°F EWT requires optional extended range insulated water and refrigerant circuits to avoid condensation within the unit cabinet.

## Performance Data – HZ H/V/D 070 (Full Load), No vFlow®

## 2050 CFM Nominal (Rated) Airflow Heating, 1850 CFM Nominal (Rated) Airflow Cooling

Performance capacities shown in thousands of Btu/h

EWT °F	GPM	WPD		COOLING - EAT 80/67 °F							HEATING - 70°F							
		PSI	FT	CFM	TC	SC	KW	HR	EER	HWC	CFM	HC	KW	HE	LAT	COP	HWC	
20	17.0	8.9	20.6								1800	46.6	4.66	31.1	94.0	2.9	4.0	
	17.0	8.9	20.6								2050	47.3	4.52	31.9	91.4	3.1	4.1	
30	8.5	2.2	5.1	1630	82.4	50.1	3.04	92.6	27.1	2.2	1800	51.6	4.78	35.6	96.5	3.2	4.2	
	8.5	2.2	5.1	1850	83.8	53.9	3.15	94.6	26.6	2.2	2050	52.4	4.63	36.6	93.7	3.3	4.3	
	12.8	4.6	10.6	1630	82.3	50.0	2.90	92.0	28.4	2.2	1800	54.0	4.83	37.8	97.8	3.3	4.1	
	12.8	4.6	10.6	1850	83.7	53.8	3.00	93.9	27.9	2.2	2050	54.8	4.68	38.8	94.8	3.4	4.2	
	17.0	7.6	17.6	1630	81.9	49.8	2.84	91.4	28.9	2.2	1800	55.3	4.86	39.0	98.4	3.3	4.1	
	17.0	7.6	17.6	1850	83.3	53.5	2.94	93.3	28.3	2.3	2050	56.1	4.71	40.1	95.3	3.5	4.2	
40	8.5	1.6	3.8	1630	81.3	49.8	3.27	92.3	24.9	2.4	1800	59.4	4.95	42.7	100.5	3.5	4.3	
	8.5	1.6	3.8	1850	82.7	53.5	3.39	94.3	24.4	2.4	2050	60.3	4.80	43.9	97.2	3.7	4.4	
	12.8	3.9	8.9	1630	82.2	50.1	3.10	92.6	26.5	2.2	1800	62.1	5.03	45.3	102.0	3.6	4.4	
	12.8	3.9	8.9	1850	83.6	53.9	3.21	94.6	26.1	2.2	2050	63.1	4.87	46.5	98.5	3.8	4.5	
	17.0	6.7	15.5	1630	82.4	50.1	3.02	92.5	27.3	2.2	1800	63.6	5.06	46.6	102.7	3.7	4.4	
	17.0	6.7	15.5	1850	83.8	53.9	3.13	94.5	26.8	2.2	2050	64.6	4.90	47.9	99.2	3.9	4.5	
50	8.5	1.3	3.0	1630	79.1	49.0	3.54	91.0	22.3	2.7	1800	66.9	5.15	49.6	104.4	3.8	4.6	
	8.5	1.3	3.0	1850	80.5	52.6	3.67	93.0	21.9	2.8	2050	67.9	4.99	50.9	100.7	4.0	4.7	
	12.8	3.4	7.8	1630	80.8	49.6	3.34	92.0	24.2	2.4	1800	70.1	5.23	52.5	106.1	3.9	4.7	
	12.8	3.4	7.8	1850	82.2	53.3	3.46	94.0	23.8	2.5	2050	71.2	5.07	53.9	102.1	4.1	4.8	
	17.0	6.0	13.9	1630	81.5	49.8	3.24	92.4	25.1	2.5	1800	71.8	5.27	54.0	106.9	4.0	4.8	
	17.0	6.0	13.9	1850	82.9	53.6	3.36	94.3	24.7	2.5	2050	72.9	5.11	55.5	102.9	4.2	4.9	
60	8.5	1.2	2.7	1630	76.1	47.8	3.87	89.2	19.7	3.3	1800	74.4	5.35	56.4	108.3	4.1	5.0	
	8.5	1.2	2.7	1850	77.4	51.4	4.01	91.1	19.3	3.3	2050	75.5	5.18	57.9	104.1	4.3	5.1	
	12.8	3.1	7.1	1630	78.3	48.7	3.63	90.6	21.6	2.9	1800	78.0	5.45	59.6	110.1	4.2	5.1	
	12.8	3.1	7.1	1850	79.7	52.3	3.76	92.5	21.2	2.9	2050	79.2	5.28	61.2	105.8	4.4	5.2	
	17.0	5.6	13.0	1630	79.3	49.1	3.51	91.2	22.6	2.7	1800	80.0	5.50	61.4	111.1	4.3	5.2	
	17.0	5.6	13.0	1850	80.7	52.7	3.64	93.1	22.2	2.8	2050	81.2	5.33	63.0	106.7	4.5	5.3	
70	8.5	1.1	2.6	1630	72.4	46.3	4.27	86.9	17.0	4.4	1800	81.9	5.55	63.1	112.1	4.3	5.4	
	8.5	1.1	2.6	1850	73.7	49.8	4.42	88.7	16.7	4.5	2050	83.2	5.38	64.8	107.6	4.5	5.5	
	12.8	3.0	6.8	1630	75.0	47.4	3.98	88.5	18.9	3.7	1800	86.0	5.68	66.7	114.2	4.4	5.6	
	12.8	3.0	6.8	1850	76.3	50.9	4.12	90.4	18.5	3.8	2050	87.3	5.50	68.5	109.4	4.7	5.7	
	17.0	5.4	12.4	1630	76.3	47.9	3.85	89.3	19.8	3.5	1800	88.2	5.75	68.7	115.4	4.5	5.7	
	17.0	5.4	12.4	1850	77.6	51.5	3.99	91.2	19.5	3.5	2050	89.5	5.57	70.5	110.4	4.7	5.8	
80	8.5	1.2	2.7	1630	68.4	44.7	4.72	84.4	14.5	5.9	1800	89.5	5.79	69.9	116.0	4.5	5.9	
	8.5	1.2	2.7	1850	69.5	48.1	4.89	86.2	14.2	6.0	2050	90.9	5.61	71.7	111.0	4.7	6.0	
	12.8	2.9	6.7	1630	71.2	45.8	4.40	86.1	16.2	5.0	1800	94.1	5.93	73.9	118.4	4.6	6.1	
	12.8	2.9	6.7	1850	72.4	49.3	4.56	88.0	15.9	5.1	2050	95.5	5.75	75.9	113.2	4.9	6.3	
	17.0	5.2	12.1	1630	72.6	46.4	4.25	87.0	17.1	4.6	1800	96.7	6.02	76.2	119.7	4.7	6.3	
	17.0	5.2	12.1	1850	73.8	49.9	4.40	88.8	16.8	4.7	2050	98.1	5.83	78.2	114.3	4.9	6.4	
85	8.5	1.2	2.7	1630	66.2	43.8	5.0	83.2	13.3	6.8	1800	93.4	5.91	73.3	118.0	4.6	6.1	
	8.5	1.2	2.7	1850	67.4	47.1	5.17	85.0	13.1	6.9	2050	94.8	5.7	75.3	112.8	4.8	6.3	
	12.8	2.9	6.7	1630	69.1	45.0	4.65	84.9	14.9	5.8	1800	98.3	6.1	77.7	120.6	4.7	6.4	
	12.8	2.9	6.7	1850	70.3	48.4	4.82	86.7	14.7	6.0	2050	99.8	5.9	79.7	115.1	5.0	6.6	
	17.0	5.2	12.1	1630	70.5	45.6	4.48	85.7	15.8	5.4	1800	101.1	6.2	80.1	122.0	4.8	6.6	
	17.0	5.2	12.1	1850	71.7	49.0	4.64	87.6	15.5	5.5	2050	102.6	6.0	82.2	116.4	5.0	6.8	
90	8.5	1.2	2.8	1630	64.1	43.0	5.26	82.0	12.2	7.7	1800	97.3	6.04	76.8	120.0	4.7	6.4	
	8.5	1.2	2.8	1850	65.2	46.2	5.45	83.8	12.0	7.9	2050	98.8	5.85	78.8	114.6	4.9	6.5	
	12.8	2.9	6.7	1630	67.0	44.1	4.89	83.6	13.7	6.7	1800	102.6	6.22	81.4	122.8	4.8	6.7	
	12.8	2.9	6.7	1850	68.1	47.4	5.07	85.4	13.4	6.8	2050	104.1	6.03	83.6	117.0	5.1	6.9	
	17.0	5.2	12.0	1630	68.4	44.7	4.71	84.5	14.5	6.2	1800	105.5	6.32	84.0	124.3	4.9	6.9	
	17.0	5.2	12.0	1850	69.6	48.1	4.88	86.3	14.3	6.3	2050	107.1	6.12	86.2	118.4	5.1	7.1	
100	8.5	1.2	2.8	1630	59.8	41.2	5.88	79.9	10.2	10.0								
	8.5	1.2	2.8	1850	60.9	44.3	6.09	81.6	10.0	10.2								
	12.8	2.9	6.7	1630	62.6	42.3	5.46	81.3	11.5	8.8								
	12.8	2.9	6.7	1850	63.7	45.5	5.66	83.0	11.3	9.0								
	17.0	5.2	12.0	1630	64.0	42.9	5.27	82.0	12.2	8.2								
	17.0	5.2	12.0	1850	65.1	46.2	5.46	83.8	11.9	8.4								
110	8.5	1.1	2.6	1630	55.7	39.5	6.61	78.3	8.4	12.7								
	8.5	1.1	2.6	1850	56.7	42.5	6.85	80.0	8.3	13.0								
	12.8	2.9	6.6	1630	58.3	40.6	6.14	79.3	9.5	11.3								
	12.8	2.9	6.6	1850	59.3	43.6	6.36	81.0	9.3	11.5								
	17.0	5.1	11.8	1630	59.6	41.1	5.91	79.9	10.1	10.6								
	17.0	5.1	11.8	1850	60.7	44.2	6.12	81.6	9.9	10.8								
120	8.5	0.9	2.1	1630	52.0	38.1	7.45	77.6	7.0	15.9								
	8.5	0.9	2.1	1850	52.9	41.0	7.72	79.2	6.8	16.2								
	12.8	2.7	6.2	1630	54.2	39.0	6.91	77.9	7.9	14.3								
	12.8	2.7	6.2	1850	55.2	41.9	7.16	79.6	7.7	14.6								
	17.0	5.0	11.5	1630	55.5	39.4	6.66	78.3	8.3	13.5								
	17.0	5.0	11.5	1850	56.4	42.4	6.90	80.0	8.2	13.8								

Interpolation is permissible, extrapolation is not. All performance data is based on the lower voltage of dual voltage units. Performance stated is at the rated power supply, performance may vary as the power supply varies from the rated. Table is with entering air of 80°F DB and 67°F WB in cooling, and 70°F DB in heating. AHRI/ISO certified conditions are 80.6°F DB and 66.2°F WB in cooling and 68°F DB in heating. Table does not reflect fan or pump power corrections for AHRI/ISO conditions. See performance correction tables for operating conditions other than those listed above. See performance data selection notes for operation in the shaded areas. Operation below 40°F EWT is based on a 15% methanol antifreeze solution. Operation below 60°F EWT requires optional extended range insulated water and refrigerant circuits to avoid condensation within the unit cabinet.

# Performance Data - HZ H/V/D 024 (Part Load), With vFlow<sup>®</sup>

## 850 CFM Nominal (Rated) Airflow Heating, 750 CFM Nominal (Rated) Airflow Cooling

Performance capacities shown in thousands of Btu/h

EWT °F	GPM	WPD		COOLING - EAT 80/67 °F								GPM	WPD			HEATING - 70°F							
		PSI	FT	CFM	TC	SC	kW	HR	EER	LWT	HWC		PSI	FT	CFM	HC	kW	HE	COP	LAT	LWT	HWC	
20	1.0	0.2	0.3	660	22.6	14.9	0.7	25.1	30.7	70.0	1.0	4.5	1.2	2.9	750	11.5	1.25	7.4	2.7	84.2	16.7	1.2	
	1.0	0.2	0.4	750	23.0	16.0	0.75	25.6	30.7	70.0	1.0	4.5	1.2	2.9	850	11.7	1.20	7.6	2.9	82.7	16.6	1.2	
30	1.3	0.2	0.4	660	22.6	14.9	0.7	25.1	30.7	70.0	1.0	2.3	0.5	1.1	750	13.0	1.23	8.9	3.1	86.0	22.2	1.3	
	1.3	0.2	0.4	750	23.0	16.0	0.75	25.6	30.7	70.0	1.0	2.3	0.5	1.1	850	13.2	1.18	9.2	3.3	84.4	22.0	1.3	
	1.3	0.2	0.4	660	22.6	14.9	0.7	25.1	30.7	70.0	1.0	3.4	0.8	1.8	750	13.6	1.22	9.5	3.3	86.8	24.4	1.3	
	1.3	0.2	0.4	750	23.0	16.0	0.75	25.6	30.7	70.0	1.0	3.4	0.8	1.8	850	13.8	1.17	9.8	3.5	85.0	24.2	1.4	
	1.3	0.2	0.4	660	22.6	14.9	0.7	25.1	30.7	70.0	1.0	4.5	1.1	2.6	750	13.9	1.21	9.9	3.4	87.2	25.6	1.4	
	1.3	0.2	0.4	750	23.0	16.0	0.75	25.6	30.7	70.0	1.0	4.5	1.1	2.6	850	14.1	1.16	10.2	3.6	85.4	25.5	1.4	
40	1.7	0.3	0.6	660	22.6	14.9	0.7	25.1	30.7	70.0	1.0	2.3	0.4	1.0	750	15.2	1.20	11.2	3.7	88.8	30.3	1.5	
	1.7	0.3	0.6	750	23.0	16.0	0.75	25.6	30.7	70.0	1.0	2.3	0.4	1.0	850	15.4	1.15	11.5	3.9	86.8	30.0	1.5	
	1.7	0.3	0.6	660	22.6	14.9	0.7	25.1	30.7	70.0	1.0	3.4	0.7	1.7	750	16.0	1.19	12.0	3.9	89.7	33.0	1.5	
	1.7	0.3	0.6	750	23.0	16.0	0.75	25.6	30.7	70.0	1.0	3.4	0.7	1.7	850	16.2	1.14	12.3	4.2	87.6	32.8	1.6	
	1.7	0.3	0.6	660	22.6	14.9	0.7	25.1	30.7	70.0	1.0	4.5	1.1	2.5	750	16.4	1.18	12.4	4.1	90.2	34.5	1.6	
	1.7	0.3	0.6	750	23.0	16.0	0.75	25.6	30.7	70.0	1.0	4.5	1.1	2.5	850	16.6	1.13	12.8	4.3	88.1	34.3	1.6	
50	2.3	0.4	1.0	660	22.4	14.9	0.8	25.0	29.7	71.7	1.1	2.3	0.4	1.0	750	17.4	1.17	13.4	4.4	91.5	38.3	1.7	
	2.3	0.4	1.0	750	22.9	15.9	0.77	25.5	29.7	72.2	1.1	2.3	0.4	1.0	850	17.7	1.12	13.8	4.6	89.2	38.0	1.7	
	2.5	0.5	1.1	660	22.6	14.9	0.7	25.1	30.7	70.0	1.0	3.4	0.7	1.6	750	18.3	1.16	14.4	4.6	92.6	41.5	1.7	
	2.6	0.5	1.1	750	23.0	16.0	0.75	25.6	30.7	70.0	1.0	3.4	0.7	1.6	850	18.6	1.11	14.8	4.9	90.3	41.3	1.8	
	2.5	0.5	1.1	660	22.6	14.9	0.7	25.1	30.7	70.0	1.0	4.5	1.0	2.3	750	18.9	1.16	14.9	4.8	93.3	43.4	1.8	
	2.6	0.5	1.1	750	23.0	16.0	0.75	25.6	30.7	70.0	1.0	4.5	1.0	2.3	850	19.1	1.11	15.4	5.1	90.8	43.2	1.8	
60	2.3	0.4	1.0	660	21.5	14.5	0.9	24.4	24.8	81.2	1.4	2.3	0.4	1.0	750	19.6	1.15	15.7	5.0	94.3	46.3	1.8	
	2.3	0.4	1.0	750	21.9	15.5	0.88	24.9	24.9	81.6	1.5	2.3	0.4	1.0	850	19.9	1.10	16.2	5.3	91.7	45.9	1.9	
	3.4	0.7	1.6	660	22.2	14.8	0.8	24.9	28.2	74.6	1.2	3.4	0.7	1.6	750	20.8	1.14	16.9	5.3	95.6	50.1	1.9	
	3.4	0.7	1.6	750	22.6	15.8	0.80	25.3	28.3	74.9	1.2	3.4	0.7	1.6	850	21.1	1.09	17.3	5.7	92.9	49.8	1.9	
	4.5	1.0	2.3	660	22.5	14.9	0.7	25.0	30.1	71.1	1.0	4.5	1.0	2.3	750	21.4	1.14	17.5	5.5	96.4	52.2	2.0	
	4.5	1.0	2.3	750	22.9	15.9	0.76	25.5	30.2	71.3	1.1	4.5	1.0	2.3	850	21.7	1.09	18.0	5.8	93.6	52.0	2.0	
70	2.3	0.4	1.0	660	20.3	14.0	1.0	23.6	20.6	90.5	2.0	2.3	0.4	1.0	750	21.9	1.14	18.0	5.7	97.1	54.3	2.0	
	2.3	0.4	1.0	750	20.7	15.0	1.00	24.1	20.7	90.9	2.0	2.3	0.4	1.0	850	22.3	1.09	18.5	6.0	94.2	53.9	2.0	
	3.4	0.7	1.6	660	21.1	14.4	0.9	24.2	23.6	84.2	1.6	3.4	0.7	1.6	750	23.2	1.14	19.3	6.0	98.7	58.6	2.1	
	3.4	0.7	1.6	750	21.5	15.4	0.91	24.6	23.7	84.5	1.6	3.4	0.7	1.6	850	23.6	1.09	19.9	6.3	95.7	58.3	2.1	
	4.5	1.0	2.2	660	21.5	14.5	0.9	24.4	25.2	80.9	1.4	4.5	1.0	2.2	750	24.0	1.14	20.1	6.2	99.6	61.1	2.1	
	4.5	1.0	2.2	750	21.9	15.6	0.87	24.9	25.2	81.1	1.4	4.5	1.0	2.2	850	24.3	1.09	20.6	6.5	96.5	60.8	2.2	
80	2.3	0.4	1.0	660	18.9	13.4	1.1	22.7	16.9	99.8	2.6	2.3	0.4	1.0	750	24.3	1.14	20.4	6.3	100.0	62.3	2.1	
	2.3	0.4	1.0	750	19.3	14.3	1.14	23.2	16.9	100.1	2.6	2.3	0.4	1.0	850	24.6	1.09	20.9	6.6	96.8	61.8	2.2	
	3.4	0.7	1.5	660	19.8	13.8	1.0	23.3	19.4	93.7	2.2	2.8	0.5	1.2	750	25.2	1.14	21.3	6.5	101.1	65.0	2.2	
	3.4	0.7	1.5	750	20.2	14.8	1.04	23.8	19.4	94.0	2.2	2.9	0.6	1.3	850	25.6	1.09	21.9	6.9	97.9	65.0	2.2	
	4.5	0.9	2.2	660	20.3	14.0	1.0	23.6	20.7	90.5	1.9	2.8	0.5	1.2	750	25.2	1.14	21.3	6.5	101.1	65.0	2.2	
	4.5	0.9	2.2	750	20.7	15.0	1.00	24.1	20.7	90.7	2.0	2.9	0.6	1.3	850	25.6	1.09	21.9	6.9	97.9	65.0	2.2	
90	2.3	0.4	1.0	660	17.5	12.7	1.3	21.8	13.7	109.0	3.4	1.7	0.3	0.6	750	25.2	1.14	21.3	6.5	101.1	65.0	2.2	
	2.3	0.4	1.0	750	17.8	13.6	1.30	22.2	13.7	109.3	3.4	1.7	0.3	0.7	850	25.6	1.09	21.9	6.9	97.9	65.0	2.2	
	3.4	0.7	1.5	660	18.4	13.1	1.2	22.4	15.7	103.2	2.9	1.7	0.3	0.6	750	25.2	1.14	21.3	6.5	101.1	65.0	2.2	
	3.4	0.7	1.5	750	18.7	14.1	1.19	22.8	15.8	103.4	2.9	1.7	0.3	0.7	850	25.6	1.09	21.9	6.9	97.9	65.0	2.2	
	4.5	0.9	2.2	660	18.9	13.4	1.1	22.7	16.9	100.1	2.6	1.7	0.3	0.6	750	25.2	1.14	21.3	6.5	101.1	65.0	2.2	
	4.5	0.9	2.2	750	19.2	14.3	1.14	23.1	16.9	100.3	2.7	1.7	0.3	0.7	850	25.6	1.09	21.9	6.9	97.9	65.0	2.2	
100	2.3	0.4	1.0	660	16.0	12.1	1.5	21.0	11.0	118.2	4.3	1.2	0.1	0.3	750	25.2	1.14	21.3	6.5	101.1	65.0	2.2	
	2.3	0.4	1.0	750	16.3	13.0	1.48	21.4	11.0	118.6	4.3	1.2	0.1	0.3	850	25.6	1.09	21.9	6.9	97.9	65.0	2.2	
	3.4	0.7	1.5	660	16.9	12.5	1.3	21.5	12.7	112.6	3.7	1.2	0.1	0.3	750	25.2	1.14	21.3	6.5	101.1	65.0	2.2	
	3.4	0.7	1.5	750	17.2	13.4	1.36	21.9	12.7	112.9	3.8	1.2	0.1	0.3	850	25.6	1.09	21.9	6.9	97.9	65.0	2.2	
	4.5	0.9	2.1	660	17.4	12.7	1.3	21.8	13.5	109.7	3.4	1.2	0.1	0.3	750	25.2	1.14	21.3	6.5	101.1	65.0	2.2	
	4.5	0.9	2.1	750	17.7	13.6	1.31	22.2	13.5	109.9	3.5	1.2	0.1	0.3	850	25.6	1.09	21.9	6.9	97.9	65.0	2.2	
110	2.3	0.4	0.9	660	14.6	11.6	1.6	20.3	8.9	127.6	5.3	0.9	0.1	0.2	750	25.2	1.14	21.3	6.5	101.1	65.0	2.2	
	2.3	0.4	0.9	750	14.9	12.4	1.68	20.6	8.9	128.0	5.4	1.0	0.1	0.2	850	25.6	1.09	21.9	6.9	97.9	65.0	2.2	
	3.4	0.7	1.5	660	15.4	11.9	1.5	20.6	10.1	122.1	4.7	0.9	0.1	0.2	750	25.2	1.14	21.3	6.5	101.1	65.0	2.2	
	3.4	0.7	1.5	750	15.7	12.7	1.56	21.0	10.1	122.4	4.8	1.0	0.1	0.2	850	25.6	1.09	21.9	6.9	97.9	65.0	2.2	
	4.5	0.9	2.1	660																			

Performance Data - HZ H/V/D 024 (Full Load), With vFlow<sup>®</sup>

950 CFM Nominal (Rated) Airflow Heating, 850 CFM Nominal (Rated) Airflow Cooling

Performance capacities shown in thousands of Btuh

EWT °F	GPM	WPD		COOLING - EAT 80/67 °F								GPM	WPD		HEATING - 70°F							
		PSI	FT	CFM	TC	SC	kW	HR	EER	LWT	HWC		PSI	FT	CFM	HC	kW	HE	COP	LAT	LWT	HWC
20	1.3	0.3	0.6	750	29.3	18.1	1.2	33.2	25.3	70.0	1.4	6.0	1.9	4.4	840	16.5	1.73	10.7	2.8	88.2	16.4	1.5
	1.4	0.3	0.6	850	29.8	19.5	1.20	33.9	24.9	70.0	1.4	6.0	1.9	4.4	950	16.8	1.68	11.0	2.9	86.3	16.3	1.5
30	1.7	0.3	0.7	750	29.3	18.1	1.2	33.2	25.3	70.0	1.4	3.0	0.7	1.6	840	18.2	1.69	12.6	3.2	90.1	21.6	1.7
	1.7	0.3	0.7	850	29.8	19.5	1.20	33.9	24.9	70.0	1.4	3.0	0.7	1.6	950	18.5	1.64	12.9	3.3	88.0	21.4	1.8
	1.7	0.3	0.7	750	29.3	18.1	1.2	33.2	25.3	70.0	1.4	4.5	1.1	2.6	840	19.1	1.68	13.4	3.3	91.0	24.0	1.8
	1.7	0.3	0.7	850	29.8	19.5	1.20	33.9	24.9	70.0	1.4	4.5	1.1	2.6	950	19.4	1.63	13.8	3.5	88.9	23.9	1.9
	1.7	0.3	0.7	750	29.3	18.1	1.2	33.2	25.3	70.0	1.4	6.0	1.8	4.0	840	19.5	1.67	13.9	3.4	91.5	25.4	1.9
	1.7	0.3	0.7	850	29.8	19.5	1.20	33.9	24.9	70.0	1.4	6.0	1.8	4.0	950	19.8	1.62	14.3	3.6	89.3	25.2	1.9
40	2.2	0.4	1.0	750	29.3	18.1	1.2	33.2	25.3	70.0	1.4	3.0	0.6	1.5	840	21.0	1.66	15.4	3.7	93.1	29.7	2.1
	2.3	0.4	1.0	850	29.8	19.5	1.20	33.9	24.9	70.0	1.4	3.0	0.6	1.5	950	21.3	1.61	15.8	3.9	90.8	29.5	2.1
	2.2	0.4	1.0	750	29.3	18.1	1.2	33.2	25.3	70.0	1.4	4.5	1.1	2.5	840	22.0	1.65	16.5	3.9	94.3	32.7	2.2
	2.3	0.4	1.0	850	29.8	19.5	1.20	33.9	24.9	70.0	1.4	4.5	1.1	2.5	950	22.4	1.60	16.9	4.1	91.8	32.5	2.3
	2.2	0.4	1.0	750	29.3	18.1	1.2	33.2	25.3	70.0	1.4	6.0	1.6	3.8	840	22.6	1.64	17.1	4.0	94.9	34.3	2.3
	2.3	0.4	1.0	850	29.8	19.5	1.20	33.9	24.9	70.0	1.4	6.0	1.6	3.8	950	23.0	1.59	17.5	4.2	92.4	34.2	2.3
50	3.0	0.6	1.4	750	29.1	18.0	1.2	33.1	24.5	72.0	1.4	3.0	0.6	1.4	840	23.8	1.64	18.2	4.2	96.2	37.8	2.4
	3.0	0.6	1.4	850	29.6	19.4	1.23	33.8	24.0	72.5	1.5	3.0	0.6	1.4	950	24.1	1.59	18.7	4.5	93.5	37.5	2.5
	3.3	0.7	1.6	750	29.3	18.1	1.2	33.2	25.3	70.0	1.4	4.5	1.0	2.3	840	25.1	1.64	19.5	4.5	97.6	41.3	2.6
	3.4	0.7	1.6	850	29.8	19.5	1.20	33.9	24.9	70.0	1.4	4.5	1.0	2.3	950	25.4	1.59	20.0	4.7	94.8	41.1	2.6
	3.3	0.7	1.6	750	29.3	18.1	1.2	33.2	25.3	70.0	1.4	6.0	1.6	3.6	840	25.8	1.64	20.2	4.6	98.4	43.3	2.7
	3.4	0.7	1.6	850	29.8	19.5	1.20	33.9	24.9	70.0	1.4	6.0	1.6	3.6	950	26.2	1.59	20.7	4.8	95.5	43.1	2.7
60	3.0	0.6	1.3	750	27.9	17.6	1.3	32.3	21.4	81.5	1.9	3.0	0.6	1.3	840	26.7	1.64	21.1	4.8	99.4	45.9	2.8
	3.0	0.6	1.3	850	28.4	18.9	1.35	33.0	21.0	82.0	1.9	3.0	0.6	1.3	950	27.1	1.59	21.6	5.0	96.4	45.6	2.8
	4.5	1.0	2.3	750	28.8	17.9	1.2	32.9	23.7	74.6	1.5	4.5	1.0	2.3	840	28.2	1.65	22.5	5.0	101.0	50.0	2.9
	4.5	1.0	2.3	850	29.3	19.3	1.26	33.6	23.3	74.9	1.6	4.5	1.0	2.3	950	28.6	1.60	23.1	5.2	97.9	49.7	3.0
	6.0	1.5	3.5	750	29.2	18.1	1.2	33.1	24.8	71.0	1.4	6.0	1.5	3.5	840	29.0	1.66	23.3	5.1	102.0	52.2	3.0
	6.0	1.5	3.5	850	29.7	19.4	1.22	33.8	24.3	71.3	1.4	6.0	1.5	3.5	950	29.4	1.61	24.0	5.4	98.7	52.0	3.1
70	3.0	0.6	1.3	750	26.4	17.0	1.4	31.3	18.5	90.9	2.4	3.0	0.6	1.3	840	29.6	1.66	23.9	5.2	102.6	54.1	3.1
	3.0	0.6	1.3	850	26.9	18.3	1.48	32.0	18.2	91.3	2.4	3.0	0.6	1.3	950	30.1	1.61	24.6	5.5	99.3	53.6	3.2
	4.5	1.0	2.2	750	27.5	17.5	1.3	32.0	20.7	84.2	2.0	4.5	1.0	2.2	840	31.4	1.69	25.6	5.4	104.6	58.6	3.3
	4.5	1.0	2.2	850	28.0	18.8	1.38	32.7	20.3	84.5	2.1	4.5	1.0	2.2	950	31.8	1.64	26.2	5.7	101.0	58.3	3.3
	6.0	1.5	3.4	750	28.0	17.7	1.3	32.4	21.8	80.8	1.8	6.0	1.5	3.4	840	32.3	1.71	26.5	5.5	105.7	61.2	3.4
	6.0	1.5	3.4	850	28.5	19.0	1.33	33.1	21.4	81.0	1.9	6.0	1.5	3.4	950	32.8	1.66	27.2	5.8	102.0	60.9	3.4
80	3.0	0.6	1.3	750	24.8	16.3	1.6	30.2	15.7	100.1	3.0	3.0	0.6	1.3	840	32.6	1.71	26.7	5.6	106.0	62.2	3.4
	3.0	0.6	1.3	850	25.2	17.5	1.64	30.8	15.4	100.5	3.0	3.0	0.6	1.3	950	33.1	1.66	27.5	5.8	103.3	61.7	3.5
	4.5	0.9	2.2	750	26.0	16.8	1.5	31.0	17.6	93.8	2.6	3.7	0.7	1.7	840	33.9	1.74	27.9	5.7	107.4	65.0	3.5
	4.5	0.9	2.2	850	26.4	18.1	1.53	31.6	17.3	94.1	2.6	3.8	0.8	1.8	950	34.4	1.69	28.7	6.0	103.6	65.0	3.6
	6.0	1.4	3.3	750	26.2	16.9	1.4	31.1	18.1	90.4	2.4	3.7	0.7	1.7	840	33.9	1.74	27.9	5.7	107.4	65.0	3.5
	6.0	1.4	3.3	850	26.7	18.2	1.50	31.8	17.8	92.7	2.4	3.8	0.8	1.8	950	34.4	1.69	28.7	6.0	103.6	65.0	3.6
90	3.0	0.6	1.3	750	23.1	15.5	1.7	29.0	13.2	109.4	3.7	2.2	0.4	0.9	840	33.9	1.74	27.9	5.7	107.4	65.0	3.5
	3.0	0.6	1.3	850	23.5	16.7	1.81	29.7	13.0	109.8	3.7	2.3	0.4	1.0	950	34.4	1.69	28.7	6.0	103.6	65.0	3.6
	4.5	0.9	2.2	750	24.3	16.1	1.6	29.8	14.9	103.2	3.2	2.2	0.4	0.9	840	33.9	1.74	27.9	5.7	107.4	65.0	3.5
	4.5	0.9	2.2	850	24.7	17.3	1.69	30.4	14.6	103.5	3.3	2.3	0.4	1.0	950	34.4	1.69	28.7	6.0	103.6	65.0	3.6
	6.0	1.4	3.2	750	24.9	16.3	1.6	30.2	15.8	100.1	3.0	2.2	0.4	0.9	840	33.9	1.74	27.9	5.7	107.4	65.0	3.5
	6.0	1.4	3.2	850	25.3	17.5	1.63	30.9	15.5	100.3	3.0	2.3	0.4	1.0	950	34.4	1.69	28.7	6.0	103.6	65.0	3.6
100	3.0	0.6	1.3	750	21.3	14.8	1.9	28.0	10.9	118.7	4.4	1.6	0.2	0.6	840	33.9	1.74	27.9	5.7	107.4	65.0	3.5
	3.0	0.6	1.3	850	21.7	15.9	2.02	28.6	10.7	119.1	4.5	1.6	0.3	0.6	950	34.4	1.69	28.7	6.0	103.6	65.0	3.6
	4.5	0.9	2.1	750	22.5	15.3	1.8	28.7	12.4	112.7	3.9	1.6	0.2	0.6	840	33.9	1.74	27.9	5.7	107.4	65.0	3.5
	4.5	0.9	2.1	850	22.9	16.4	1.88	29.3	12.2	113.0	4.0	1.6	0.3	0.6	950	34.4	1.69	28.7	6.0	103.6	65.0	3.6
	6.0	1.4	3.2	750	23.1	15.5	1.8	29.0	13.1	109.7	3.7	1.6	0.2	0.6	840	33.9	1.74	27.9	5.7	107.4	65.0	3.5
	6.0	1.4	3.2	850	23.5	16.7	1.82	29.7	12.9	109.9	3.7	1.6	0.3	0.6	950	34.4	1.69	28.7	6.0	103.6	65.0	3.6
110	3.0	0.6	1.3	750	19.7	14.2	2.2	27.1	9.0	128.1	5.3	1.2	0.1	0.3	840	33.9	1.74	27.9	5.7	107.4	65.0	3.5
	3.0	0.6	1.3	850	20.0	15.2	2.26	27.7	8.9	128.5	5.4	1.3	0.1	0.3	950	34.4	1.69	28.7	6.0	103.6	65.0	3.6
	4.5	0.9	2.1	750	20.7	14.6	2.0	27.7	10.2	122.3	4.7	1.2	0.1	0.3	840	33.9	1.74	27.9	5.7	107.4	65.0	3.5
	4.5	0.9	2.1	850	21.1	15.7	2.11	28.2	10.0	122.6	4.8	1.3	0.1	0.3	950	34.4	1.69	28.7	6.0			





# Performance Data - HZ H/V/D 036 (Part Load), With vFlow®

## 1000 CFM Nominal (Rated) Airflow Heating, 1000 CFM Nominal (Rated) Airflow Cooling

Performance capacities shown in thousands of Btu/h

EWT °F	GPM	WPD		COOLING - EAT 80/67 °F								GPM	WPD			HEATING - 70°F							
		PSI	FT	CFM	TC	SC	kW	HR	EER	LWT	HWC		PSI	FT	CFM	HC	kW	HE	COP	LAT	LWT	HWC	
20	1.5	0.4	1.0	880	32.8	20.8	1.0	36.3	32.5	70.0	1.2	6.0	2.5	5.7	880	16.9	1.65	11.5	3.0	87.8	16.2	1.7	
	1.5	0.4	1.0	1000	33.5	22.2	1.03	37.0	32.5	70.0	1.2	6.0	2.5	5.7	1000	17.2	1.58	11.8	3.2	85.9	16.1	1.7	
30	1.8	0.5	1.1	880	32.8	20.8	1.0	36.3	32.5	70.0	1.2	3.0	0.9	2.1	880	18.9	1.65	13.4	3.4	89.8	21.1	1.8	
	1.8	0.5	1.1	1000	33.5	22.2	1.03	37.0	32.5	70.0	1.2	3.0	0.9	2.1	1000	19.1	1.58	13.7	3.5	87.7	20.8	1.8	
	1.8	0.5	1.1	880	32.8	20.8	1.0	36.3	32.5	70.0	1.2	4.5	1.5	3.5	880	19.9	1.64	14.4	3.6	90.9	23.6	1.9	
	1.8	0.5	1.1	1000	33.5	22.2	1.03	37.0	32.5	70.0	1.2	4.5	1.5	3.5	1000	20.2	1.57	14.8	3.8	88.7	23.4	1.9	
	1.8	0.5	1.1	880	32.8	20.8	1.0	36.3	32.5	70.0	1.2	6.0	2.2	5.1	880	20.4	1.64	14.9	3.7	91.5	25.0	2.0	
	1.8	0.5	1.1	1000	33.5	22.2	1.03	37.0	32.5	70.0	1.2	6.0	2.2	5.1	1000	20.7	1.57	15.4	3.9	89.2	24.9	2.0	
40	2.4	0.6	1.4	880	32.8	20.8	1.0	36.3	32.5	70.0	1.2	3.0	0.8	1.9	880	21.9	1.64	16.4	3.9	93.1	29.1	2.1	
	2.5	0.6	1.5	1000	33.5	22.2	1.03	37.0	32.5	70.0	1.2	3.0	0.8	1.9	1000	22.2	1.57	16.9	4.2	90.6	28.8	2.1	
	2.4	0.6	1.4	880	32.8	20.8	1.0	36.3	32.5	70.0	1.2	4.5	1.4	3.2	880	23.1	1.64	17.6	4.1	94.3	32.2	2.2	
	2.5	0.6	1.5	1000	33.5	22.2	1.03	37.0	32.5	70.0	1.2	4.5	1.4	3.2	1000	23.5	1.57	18.1	4.4	91.7	32.0	2.2	
	2.4	0.6	1.4	880	32.8	20.8	1.0	36.3	32.5	70.0	1.2	6.0	2.0	4.7	880	23.8	1.64	18.3	4.3	95.1	33.9	2.3	
	2.5	0.6	1.5	1000	33.5	22.2	1.03	37.0	32.5	70.0	1.2	6.0	2.0	4.7	1000	24.1	1.57	18.8	4.5	92.4	33.7	2.3	
50	3.0	0.8	1.8	880	32.3	20.7	1.1	36.0	29.9	74.0	1.4	3.0	0.8	1.8	880	24.9	1.64	19.4	4.5	96.2	37.1	2.4	
	3.0	0.8	1.8	1000	33.0	22.2	1.10	36.7	30.0	74.5	1.4	3.0	0.8	1.8	1000	25.3	1.57	19.9	4.7	93.4	36.7	2.4	
	3.6	1.0	2.3	880	32.8	20.8	1.0	36.3	32.5	70.0	1.2	4.5	1.3	3.0	880	26.3	1.64	20.7	4.7	97.7	40.8	2.5	
	3.7	1.0	2.4	1000	33.5	22.2	1.03	37.0	32.5	70.0	1.2	4.5	1.3	3.0	1000	26.7	1.57	21.3	5.0	94.7	40.5	2.5	
	3.6	1.0	2.3	880	32.8	20.8	1.0	36.3	32.5	70.0	1.2	6.0	1.9	4.4	880	27.1	1.64	21.5	4.8	98.5	42.8	2.6	
	3.7	1.0	2.4	1000	33.5	22.2	1.03	37.0	32.5	70.0	1.2	6.0	1.9	4.4	1000	27.5	1.57	22.1	5.1	95.4	42.6	2.6	
60	3.0	0.8	1.8	880	30.8	20.2	1.2	35.0	24.9	83.3	2.0	3.0	0.8	1.8	880	27.9	1.65	22.3	5.0	99.3	45.2	2.6	
	3.0	0.8	1.8	1000	31.4	21.6	1.26	35.7	24.9	83.8	2.0	3.0	0.8	1.8	1000	28.3	1.58	22.9	5.2	96.2	44.7	2.6	
	4.5	1.3	2.9	880	32.1	20.6	1.1	35.9	28.9	75.9	1.5	4.5	1.3	2.9	880	29.5	1.65	23.8	5.2	101.0	49.4	2.7	
	4.5	1.3	2.9	1000	32.7	22.1	1.13	36.6	29.0	76.3	1.5	4.5	1.3	2.9	1000	29.9	1.58	24.5	5.5	97.7	49.1	2.8	
	6.0	1.8	4.2	880	32.6	20.8	1.1	36.2	31.0	72.1	1.3	6.0	1.8	4.2	880	30.4	1.65	24.7	5.4	102.0	51.8	2.7	
	6.0	1.8	4.2	1000	33.2	22.2	1.07	36.9	31.1	72.3	1.3	6.0	1.8	4.2	1000	30.8	1.58	25.4	5.7	98.5	51.5	2.8	
70	3.0	0.8	1.8	880	28.8	19.4	1.4	33.6	20.4	92.4	2.6	3.0	0.8	1.8	880	30.8	1.66	25.2	5.4	102.4	53.2	2.8	
	3.0	0.8	1.8	1000	29.4	20.7	1.44	34.3	20.4	92.8	2.7	3.0	0.8	1.8	1000	31.3	1.59	25.9	5.8	99.0	52.8	2.9	
	4.5	1.2	2.9	880	30.4	20.0	1.3	34.7	23.8	85.4	2.1	4.5	1.2	2.9	880	32.7	1.67	27.0	5.7	104.4	58.0	2.9	
	4.5	1.2	2.9	1000	31.0	21.4	1.30	35.4	23.8	85.7	2.1	4.5	1.2	2.9	1000	33.2	1.60	27.7	6.1	100.7	57.7	3.0	
	6.0	1.8	4.1	880	31.1	20.3	1.2	35.2	25.8	81.7	1.9	6.0	1.8	4.1	880	33.7	1.67	28.0	5.9	105.5	60.7	3.0	
	6.0	1.8	4.1	1000	31.7	21.7	1.23	35.9	25.8	82.0	1.9	6.0	1.8	4.1	1000	34.2	1.60	28.7	6.3	101.7	60.4	3.1	
80	3.0	0.8	1.9	880	26.6	18.4	1.6	32.1	16.5	101.4	3.6	3.0	0.8	1.9	880	33.9	1.67	28.1	5.9	105.6	61.3	3.0	
	3.0	0.8	1.9	1000	27.1	19.7	1.64	32.7	16.5	101.8	3.7	3.0	0.8	1.9	1000	34.3	1.60	28.9	6.3	101.8	60.8	3.1	
	4.5	1.2	2.9	880	28.3	19.1	1.5	33.2	19.3	94.8	2.9	4.0	1.1	2.5	880	35.5	1.69	29.7	6.2	107.4	65.0	3.1	
	4.5	1.2	2.9	1000	28.8	20.5	1.49	33.9	19.3	95.1	3.0	4.0	1.1	2.6	1000	36.0	1.62	30.5	6.5	103.4	65.0	3.2	
	6.0	1.7	4.0	880	29.1	19.5	1.4	33.8	21.0	91.3	2.6	4.0	1.1	2.5	880	35.5	1.69	29.7	6.2	107.4	65.0	3.1	
	6.0	1.7	4.0	1000	29.7	20.9	1.41	34.5	21.0	91.5	2.6	4.0	1.1	2.5	1000	36.0	1.62	30.5	6.5	103.4	65.0	3.2	
90	3.0	0.8	1.9	880	24.4	17.4	1.8	30.7	13.3	110.4	4.7	2.4	0.7	1.5	880	35.5	1.69	29.7	6.2	107.4	65.0	3.1	
	3.0	0.8	1.9	1000	24.9	18.7	1.87	31.3	13.3	110.8	4.8	2.4	0.7	1.6	1000	36.0	1.62	30.5	6.5	103.4	65.0	3.2	
	4.5	1.2	2.9	880	26.0	18.1	1.7	31.7	15.6	104.1	3.9	2.4	0.7	1.5	880	35.5	1.69	29.7	6.2	107.4	65.0	3.1	
	4.5	1.2	2.9	1000	26.5	19.4	1.70	32.3	15.6	104.3	4.0	2.4	0.7	1.6	1000	36.0	1.62	30.5	6.5	103.4	65.0	3.2	
	6.0	1.7	4.0	880	26.8	18.5	1.6	32.2	16.9	100.7	3.5	2.4	0.7	1.5	880	35.5	1.69	29.7	6.2	107.4	65.0	3.1	
	6.0	1.7	4.0	1000	27.3	19.8	1.62	32.9	16.9	101.0	3.6	2.4	0.7	1.6	1000	36.0	1.62	30.5	6.5	103.4	65.0	3.2	
100	3.0	0.8	1.9	880	22.5	16.6	2.1	29.6	10.7	119.7	6.1	1.7	0.5	1.2	880	35.5	1.69	29.7	6.2	107.4	65.0	3.1	
	3.0	0.8	1.9	1000	22.9	17.8	2.13	30.1	10.7	120.1	6.2	1.7	0.5	1.2	1000	36.0	1.62	30.5	6.5	103.4	65.0	3.2	
	4.5	1.2	2.8	880	23.8	17.1	1.9	30.3	12.5	113.5	5.1	1.7	0.5	1.2	880	35.5	1.69	29.7	6.2	107.4	65.0	3.1	
	4.5	1.2	2.8	1000	24.2	18.4	1.94	30.9	12.5	113.7	5.2	1.7	0.5	1.2	1000	36.0	1.62	30.5	6.5	103.4	65.0	3.2	
	6.0	1.7	3.9	880	24.5	17.5	1.8	30.7	13.4	110.2	4.6	1.7	0.5	1.2	880	35.5	1.69	29.7	6.2	107.4	65.0	3.1	
	6.0	1.7	3.9	1000	25.0	18.7	1.86	31.3	13.4	110.4	4.7	1.7	0.5	1.2	1000	36.0	1.62	30.5	6.5	103.4	65.0	3.2	
110	3.0	0.8	1.8	880	21.0	16.3	2.4	29.1	8.8	129.4	7.7	1.3	0.4	0.9	880	35.5	1.69	29.7	6.2	107.4	65.0	3.1	
	3.0	0.8	1.8	1000	21.4	17.4	2.43	29.7	8.8	129.8	7.8	1.4	0.4	0.9	1000	36.0	1.62	30.5	6.5	103.4	65.0	3.2	
	4.5	1.2	2.8	880	21.9	16.4	2.2	29.3	10.0	123.0	6.6	1.3	0.4	0.9	880	35.5	1.69	29.7	6.2	107.4	65.0	3.1	
	4.5	1.2	2.8	1000	22.3	17.6	2.23	29.9	10.0	123.3	6.7	1.4	0.4	0.9	1000	36.0	1.62	30.5	6.5	103.4	65.0	3.2	

# Performance Data - HZ H/V/D 036 (Full Load), With vFlow®

## 1250 CFM Nominal (Rated) Airflow Heating, 1250 CFM Nominal (Rated) Airflow Cooling

Performance capacities shown in thousands of Btu/h

EWT °F	GPM		WPD		COOLING - EAT 80/67 °F							GPM		WPD		HEATING - 70°F								
					CFM	TC	SC	kW	HR	EER	LWT					HWC	CFM	HC	kW	HE	COP	LAT	LWT	HWC
20	2.0	0.6	1.5	1100	44.2	26.6	1.7	49.9	26.0	70.0	1.8	9.0	4.3	9.9	1100	25.2	2.23	17.8	3.3	91.2	16.1	2.0		
	2.0	0.7	1.5	1250	45.0	28.6	1.76	51.0	25.6	70.0	1.8	9.0	4.3	9.9	1250	25.6	2.16	18.2	3.5	89.0	15.9	2.1		
30	2.5	0.7	1.7	1100	44.2	26.6	1.7	49.9	26.0	70.0	1.8	4.5	1.5	3.5	1100	27.7	2.25	20.1	3.6	93.3	21.0	2.3		
	2.5	0.7	1.7	1250	45.0	28.6	1.76	51.0	25.6	70.0	1.8	4.5	1.5	3.5	1250	28.1	2.18	20.7	3.8	90.8	20.8	2.4		
	2.5	0.7	1.7	1100	44.2	26.6	1.7	49.9	26.0	70.0	1.8	6.8	2.6	6.1	1100	29.0	2.26	21.4	3.8	94.4	23.7	2.5		
	2.5	0.7	1.7	1250	45.0	28.6	1.76	51.0	25.6	70.0	1.8	6.8	2.6	6.1	1250	29.5	2.19	22.0	3.9	91.8	23.5	2.5		
	2.5	0.7	1.7	1100	44.2	26.6	1.7	49.9	26.0	70.0	1.8	9.0	3.9	9.1	1100	29.7	2.26	22.1	3.9	95.0	25.1	2.6		
	2.5	0.7	1.7	1250	45.0	28.6	1.76	51.0	25.6	70.0	1.8	9.0	3.9	9.1	1250	30.2	2.19	22.7	4.0	92.4	25.0	2.6		
40	3.3	0.9	2.2	1100	44.2	26.6	1.7	49.9	26.0	70.0	1.8	4.5	1.4	3.2	1100	31.8	2.28	24.0	4.1	96.7	29.3	2.8		
	3.3	1.0	2.2	1250	45.0	28.6	1.76	51.0	25.6	70.0	1.8	4.5	1.4	3.2	1250	32.2	2.21	24.7	4.3	93.9	29.0	2.9		
	3.3	0.9	2.2	1100	44.2	26.6	1.7	49.9	26.0	70.0	1.8	6.8	2.4	5.6	1100	33.3	2.30	25.5	4.2	98.1	32.5	3.0		
	3.3	1.0	2.2	1250	45.0	28.6	1.76	51.0	25.6	70.0	1.8	6.8	2.4	5.6	1250	33.8	2.23	26.2	4.4	95.1	32.3	3.1		
	3.3	0.9	2.2	1100	44.2	26.6	1.7	49.9	26.0	70.0	1.8	9.0	3.6	8.4	1100	34.2	2.31	26.3	4.3	98.8	34.1	3.1		
	3.3	1.0	2.2	1250	45.0	28.6	1.76	51.0	25.6	70.0	1.8	9.0	3.6	8.4	1250	34.7	2.24	27.1	4.5	95.7	34.0	3.2		
50	4.5	1.3	3.0	1100	43.9	26.6	1.7	49.7	25.3	72.1	2.0	4.5	1.3	3.0	1100	35.8	2.33	27.9	4.5	100.1	37.6	3.3		
	4.5	1.3	3.0	1250	44.6	28.6	1.80	50.8	24.8	72.6	2.0	4.5	1.3	3.0	1250	36.3	2.26	28.6	4.7	96.9	37.3	3.4		
	5.0	1.5	3.4	1100	44.2	26.6	1.7	49.9	26.0	70.0	1.8	6.8	2.3	5.2	1100	37.6	2.36	29.6	4.7	101.6	41.3	3.5		
	5.0	1.5	3.4	1250	45.0	28.6	1.76	51.0	25.6	70.0	1.8	6.8	2.3	5.2	1250	38.2	2.29	30.3	4.9	98.3	41.1	3.6		
	5.0	1.5	3.4	1100	44.2	26.6	1.7	49.9	26.0	70.0	1.8	9.0	3.4	7.9	1100	38.6	2.38	30.5	4.7	102.5	43.2	3.6		
	5.0	1.5	3.4	1250	45.0	28.6	1.76	51.0	25.6	70.0	1.8	9.0	3.4	7.9	1250	39.2	2.31	31.3	5.0	99.0	43.0	3.7		
60	4.5	1.3	2.9	1100	42.3	26.1	1.9	48.7	22.3	81.7	2.6	4.5	1.3	2.9	1100	39.8	2.40	31.6	4.9	103.5	45.9	3.7		
	4.5	1.3	2.9	1250	43.0	28.1	1.97	49.8	21.9	82.1	2.7	4.5	1.3	2.9	1250	40.4	2.33	32.5	5.1	99.9	45.6	3.8		
	6.8	2.1	4.9	1100	43.5	26.5	1.8	49.5	24.5	74.6	2.1	6.8	2.2	5.0	1100	41.9	2.45	33.5	5.0	105.2	50.1	4.0		
	6.8	2.1	4.9	1250	44.3	28.5	1.84	50.6	24.1	75.0	2.2	6.8	2.2	5.0	1250	42.5	2.37	34.4	5.3	101.5	49.9	4.1		
	9.0	3.3	7.5	1100	44.0	26.6	1.7	49.8	25.6	71.1	1.9	9.0	3.3	7.5	1100	43.0	2.47	34.6	5.1	106.2	52.3	4.1		
	9.0	3.3	7.5	1250	44.8	28.6	1.78	50.9	25.2	71.3	1.9	9.0	3.3	7.5	1250	43.7	2.39	35.5	5.4	102.3	52.1	4.2		
70	4.5	1.2	2.9	1100	40.4	25.4	2.1	47.4	19.5	91.1	3.4	4.5	1.2	2.9	1100	43.9	2.49	35.4	5.2	106.9	54.3	4.2		
	4.5	1.2	2.9	1250	41.1	27.4	2.15	48.4	19.1	91.5	3.5	4.5	1.2	2.9	1250	44.5	2.41	36.3	5.4	103.0	53.9	4.3		
	6.8	2.1	4.8	1100	41.8	26.0	1.9	48.4	21.5	84.2	2.8	6.8	2.1	4.8	1100	46.2	2.55	37.5	5.3	108.9	59.0	4.5		
	6.8	2.1	4.8	1250	42.6	27.9	2.02	49.4	21.1	84.6	2.9	6.8	2.1	4.8	1250	46.9	2.47	38.5	5.6	104.8	58.7	4.6		
	9.0	3.1	7.2	1100	42.5	26.2	1.9	48.8	22.6	80.9	2.5	9.0	3.1	7.2	1100	47.6	2.58	38.7	5.4	110.0	61.4	4.6		
	9.0	3.1	7.2	1250	43.2	28.2	1.95	49.9	22.2	81.1	2.6	9.0	3.1	7.2	1250	48.3	2.50	39.8	5.7	105.8	61.2	4.7		
80	4.5	1.2	2.9	1100	38.2	24.6	2.3	45.9	16.7	100.4	4.3	4.5	1.2	2.9	1100	48.0	2.59	39.2	5.4	110.4	62.6	4.6		
	4.5	1.2	2.9	1250	38.8	26.4	2.37	46.9	16.4	100.9	4.4	4.5	1.2	2.9	1250	48.8	2.51	40.2	5.7	106.1	62.1	4.7		
	6.8	2.0	4.7	1100	39.8	25.2	2.1	47.0	18.6	93.8	3.6	5.4	1.5	3.5	1100	49.5	2.63	40.5	5.5	111.7	65.0	4.8		
	6.8	2.0	4.7	1250	40.5	27.1	2.21	48.0	18.3	94.2	3.7	5.5	1.6	3.6	1250	50.3	2.55	41.6	5.8	107.3	65.0	4.9		
	9.0	3.1	7.1	1100	40.5	25.5	2.1	47.5	19.6	90.6	3.3	5.4	1.5	3.5	1100	49.5	2.63	40.5	5.5	111.7	65.0	4.8		
	9.0	3.1	7.1	1250	41.2	27.4	2.14	48.5	19.3	90.8	3.4	5.5	1.6	3.6	1250	50.3	2.55	41.6	5.8	107.3	65.0	4.9		
90	4.5	1.2	2.9	1100	35.8	23.6	2.5	44.4	14.1	109.7	5.3	3.2	0.9	2.0	1100	49.5	2.63	40.5	5.5	111.7	65.0	4.8		
	4.5	1.2	2.9	1250	36.4	25.4	2.63	45.4	13.8	110.2	5.5	3.3	0.9	2.1	1250	50.3	2.55	41.6	5.8	107.3	65.0	4.9		
	6.8	2.0	4.6	1100	37.4	24.3	2.4	45.5	15.8	103.4	4.6	3.2	0.9	2.0	1100	49.5	2.63	40.5	5.5	111.7	65.0	4.8		
	6.8	2.0	4.6	1250	38.1	26.1	2.45	46.4	15.5	103.8	4.7	3.3	0.9	2.1	1250	50.3	2.55	41.6	5.8	107.3	65.0	4.9		
	9.0	3.0	6.9	1100	38.3	24.6	2.3	46.0	16.8	100.2	4.3	3.2	0.9	2.0	1100	49.5	2.63	40.5	5.5	111.7	65.0	4.8		
	9.0	3.0	6.9	1250	38.9	26.5	2.36	47.0	16.5	100.4	4.3	3.3	0.9	2.1	1250	50.3	2.55	41.6	5.8	107.3	65.0	4.9		
100	4.5	1.2	2.8	1100	33.3	22.5	2.8	43.0	11.8	119.1	6.5	2.3	0.7	1.5	1100	49.5	2.63	40.5	5.5	111.7	65.0	4.8		
	4.5	1.2	2.8	1250	33.9	24.2	2.93	43.9	11.6	119.5	6.7	2.4	0.7	1.5	1250	50.3	2.55	41.6	5.8	107.3	65.0	4.9		
	6.8	2.0	4.5	1100	35.0	23.2	2.6	43.9	13.3	112.9	5.7	2.3	0.7	1.5	1100	49.5	2.63	40.5	5.5	111.7	65.0	4.8		
	6.8	2.0	4.5	1250	35.6	25.0	2.72	44.9	13.1	113.3	5.9	2.4	0.7	1.5	1250	50.3	2.55	41.6	5.8	107.3	65.0	4.9		
	9.0	3.0	6.8	1100	35.8	23.6	2.5	44.4	14.1	109.9	5.3	2.3	0.7	1.5	1100	49.5	2.63	40.5	5.5	111.7	65.0	4.8		
	9.0	3.0	6.8	1250	36.4	25.4	2.63	45.4	13.9	110.1	5.5	2.4	0.7	1.5	1250	50.3	2.55	41.6	5.8	107.3	65.0	4.9		
110	4.5	1.2	2.8	1100	30.9	21.4	3.2	41.7	9.7	128.5	7.9	1.8	0.5	1.2	1100	49.5	2.63	40.5	5.5	111.7	65.0	4.8		
	4.5	1.2	2.8	1250	31.4	23.0	3.29	42.6	9.5	128.9	8.0	1.8	0.5	1.2	1250	50.3	2.55	41.6	5.8	107.3	65.0	4.9		
	6.8	1.9	4.5	1100	32.4	22.1	2.9	42.5	11.0	122.5	7.0	1.8	0.5	1.2	1100	49.5	2.63	40.5	5.5	111.7	65.0	4.8		
	6.8	1.9	4.5	1250	33.0	23.8	3.05	43.4	10.8	122.9	7.1	1.8	0.5	1.2	1250	50.3	2.55	41.6	5.8	107.3	65.0	4.9		
	9.0	2.9	6.7	1100	33.3	22.5	2.8	42.9	11.7	119.5	6.6	1.8	0.5	1.2	1100	49.5	2.63	40.5	5.5	111.7	65.0	4.8		
	9.0	2.9	6.7	1250	33.8	24.2	2.94	43.9	11.5	119.7	6.7	1.8	0.5	1.2	1250	50.3	2.55	41.6	5.8	107.3	65.0	4.9		
120	4.5	1.1	2.6	1100	28.5	20.3	3.6	40.8	7.9	138.1	9.4	1.5	0.4	0.8	1100	49.5	2.63	40.5	5.5	111.7	65.0	4.8		
	4.5	1.1	2.6	1250	29.0	21.9	3.72	41.7	7.8	138.5	9.6	1.5	0.4	0.8	1250	50.3	2.55	41.6	5.8	107.3	65.0	4.9		
	6.8	1.9	4.3	1100	29.9	21.0	3.3	41.3	9.0	132.2	8.4	1.5	0.4	0.8	1100	49.5	2.63	40.5	5.5	111.7	65.0	4.8		
	6.8	1.9	4.3	1250	30																			

# Performance Data - HZ H/V/D 048 (Part Load), With vFlow®

## 1350 CFM Nominal (Rated) Airflow Heating, 1350 CFM Nominal (Rated) Airflow Cooling

Performance capacities shown in thousands of Btu/h

EWT °F	GPM	WPD		COOLING - EAT 80/67 °F								WPD		HEATING - 70°F								
		PSI	FT	CFM	TC	SC	kW	HR	EER	LWT	HWC	GPM	PSI	FT	CFM	HC	kW	HE	COP	LAT	LWT	HWC
20	1.8	0.1	0.1	1190	41.3	27.9	1.4	46.2	29.0	70.0	1.5	9.0	2.3	5.4	1190	22.8	2.38	14.9	2.8	87.7	16.7	2.5
	1.9	0.1	0.1	1350	42.1	29.9	1.45	47.1	29.0	70.0	1.5	9.0	2.3	5.4	1350	23.1	2.28	15.3	3.0	85.8	16.6	2.5
30	2.3	0.1	0.1	1190	41.3	27.9	1.4	46.2	29.0	70.0	1.5	4.5	0.2	0.6	1190	25.0	2.35	17.2	3.1	89.4	22.4	2.6
	2.4	0.1	0.1	1350	42.1	29.9	1.45	47.1	29.0	70.0	1.5	4.5	0.2	0.6	1350	25.3	2.25	17.6	3.3	87.4	22.2	2.6
	2.3	0.1	0.1	1190	41.3	27.9	1.4	46.2	29.0	70.0	1.5	6.8	1.2	2.8	1190	25.9	2.34	18.1	3.3	90.2	24.7	2.6
	2.4	0.1	0.1	1350	42.1	29.9	1.45	47.1	29.0	70.0	1.5	6.8	1.2	2.8	1350	26.3	2.24	18.6	3.4	88.0	24.5	2.6
	2.3	0.1	0.1	1190	41.3	27.9	1.4	46.2	29.0	70.0	1.5	9.0	2.1	4.9	1190	26.5	2.34	18.7	3.3	90.6	25.9	2.6
	2.4	0.1	0.1	1350	42.1	29.9	1.45	47.1	29.0	70.0	1.5	9.0	2.1	4.9	1350	26.8	2.24	19.2	3.5	88.4	25.7	2.6
40	3.1	0.1	0.1	1190	41.3	27.9	1.4	46.2	29.0	70.0	1.5	4.5	0.2	0.4	1190	28.5	2.33	20.8	3.6	92.2	30.8	2.6
	3.1	0.1	0.1	1350	42.1	29.9	1.45	47.1	29.0	70.0	1.5	4.5	0.2	0.4	1350	28.9	2.23	21.3	3.8	89.8	30.5	2.7
	3.1	0.1	0.1	1190	41.3	27.9	1.4	46.2	29.0	70.0	1.5	6.8	1.1	2.5	1190	29.8	2.33	22.0	3.8	93.2	33.5	2.6
	3.1	0.1	0.1	1350	42.1	29.9	1.45	47.1	29.0	70.0	1.5	6.8	1.1	2.5	1350	30.2	2.23	22.6	4.0	90.7	33.3	2.7
	3.1	0.1	0.1	1190	41.3	27.9	1.4	46.2	29.0	70.0	1.5	9.0	2.0	4.6	1190	30.5	2.32	22.7	3.9	93.7	35.0	2.6
	3.1	0.1	0.1	1350	42.1	29.9	1.45	47.1	29.0	70.0	1.5	9.0	2.0	4.6	1350	30.9	2.22	23.3	4.1	91.2	34.8	2.7
50	4.5	0.1	0.3	1190	41.2	28.0	1.4	46.1	28.6	70.5	1.5	4.5	0.1	0.3	1190	32.3	2.32	24.5	4.1	95.2	39.1	2.7
	4.5	0.1	0.3	1350	42.0	30.0	1.47	47.0	28.6	70.9	1.5	4.5	0.1	0.3	1350	32.8	2.22	25.2	4.3	92.5	38.8	2.8
	4.6	0.2	0.4	1190	41.3	27.9	1.4	46.2	29.0	70.0	1.5	6.8	1.0	2.4	1190	33.9	2.33	26.1	4.3	96.4	42.3	2.8
	4.7	0.2	0.5	1350	42.1	29.9	1.45	47.1	29.0	70.0	1.5	6.8	1.0	2.4	1350	34.4	2.23	26.8	4.5	93.6	42.1	2.9
	4.6	0.2	0.4	1190	41.3	27.9	1.4	46.2	29.0	70.0	1.5	9.0	1.9	4.3	1190	34.8	2.33	26.9	4.4	97.1	44.0	2.8
	4.7	0.2	0.5	1350	42.1	29.9	1.45	47.1	29.0	70.0	1.5	9.0	1.9	4.3	1350	35.3	2.23	27.7	4.6	94.2	43.9	2.9
60	4.5	0.1	0.2	1190	39.8	27.8	1.7	45.5	24.0	80.2	2.1	4.5	0.1	0.2	1190	36.3	2.33	28.4	4.6	98.3	47.4	2.9
	4.5	0.1	0.2	1350	40.6	29.8	1.69	46.4	24.0	80.6	2.1	4.5	0.1	0.2	1350	36.8	2.23	29.2	4.8	95.3	47.0	3.0
	6.8	1.0	2.2	1190	40.9	28.0	1.5	46.0	27.2	73.5	1.7	6.8	1.0	2.2	1190	38.2	2.34	30.3	4.8	99.7	51.1	3.0
	6.8	1.0	2.2	1350	41.7	30.0	1.53	46.9	27.2	73.9	1.7	6.8	1.0	2.2	1350	38.7	2.24	31.1	5.1	96.6	50.9	3.1
	9.0	1.8	4.2	1190	41.3	28.0	1.4	46.2	28.8	70.3	1.5	9.0	1.8	4.2	1190	39.2	2.35	31.3	4.9	100.5	53.1	3.0
	9.0	1.8	4.2	1350	42.1	29.9	1.46	47.0	28.8	70.5	1.5	9.0	1.8	4.2	1350	39.8	2.25	32.1	5.2	97.3	52.9	3.1
70	4.5	0.1	0.2	1190	37.9	27.1	1.9	44.4	19.9	89.7	2.7	4.5	0.1	0.2	1190	40.4	2.35	32.4	5.0	101.4	55.6	3.1
	4.5	0.1	0.2	1350	38.6	29.0	1.94	45.2	19.9	90.1	2.8	4.5	0.1	0.2	1350	41.0	2.25	33.3	5.3	98.1	55.2	3.2
	6.8	0.9	2.1	1190	39.3	27.7	1.7	45.2	22.7	83.3	2.3	6.8	0.9	2.2	1190	42.6	2.36	34.5	5.3	103.1	59.8	3.2
	6.8	0.9	2.1	1350	40.0	29.6	1.76	46.1	22.7	83.6	2.3	6.8	0.9	2.2	1350	43.2	2.26	35.5	5.6	99.6	59.6	3.3
	9.0	1.8	4.0	1190	39.9	27.9	1.6	45.5	24.2	80.1	2.1	9.0	1.8	4.0	1190	43.8	2.37	35.7	5.4	104.1	62.1	3.3
	9.0	1.8	4.0	1350	40.7	29.8	1.68	46.4	24.2	80.3	2.1	9.0	1.8	4.0	1350	44.4	2.27	36.7	5.7	100.5	61.9	3.4
80	4.5	0.1	0.3	1190	35.5	26.0	2.2	42.9	16.3	99.1	3.7	4.5	0.1	0.3	1190	44.6	2.37	36.4	5.5	104.7	63.8	3.3
	4.5	0.1	0.3	1350	36.2	27.8	2.22	43.7	16.3	99.4	3.8	4.5	0.1	0.3	1350	45.2	2.27	37.4	5.8	101.0	63.4	3.4
	6.8	0.9	2.1	1190	37.1	26.7	2.0	43.9	18.6	92.9	3.0	5.0	0.1	0.2	1190	45.4	2.38	37.2	5.6	105.3	65.0	3.4
	6.8	0.9	2.1	1350	37.8	28.6	2.03	44.7	18.6	93.3	3.1	5.0	0.1	0.2	1350	46.0	2.28	38.3	5.9	101.6	65.0	3.5
	9.0	1.7	3.9	1190	37.9	27.1	1.9	44.4	19.9	89.9	3.3	5.0	0.3	0.7	1190	45.4	2.38	37.2	5.6	105.3	65.0	3.6
	9.0	1.7	3.9	1350	38.6	29.0	1.94	45.2	19.9	90.0	3.4	5.0	0.3	0.8	1350	46.0	2.28	38.3	5.9	101.6	65.0	3.7
90	4.5	0.1	0.3	1190	32.9	24.7	2.5	41.4	13.2	108.4	4.8	3.0	0.1	0.1	1190	45.4	2.38	37.2	5.6	105.3	65.0	3.4
	4.5	0.1	0.3	1350	33.5	26.5	2.54	42.2	13.2	108.7	4.9	3.0	0.1	0.1	1350	46.0	2.28	38.3	5.9	101.6	65.0	3.5
	6.8	0.9	2.1	1190	34.6	25.5	2.3	42.4	15.1	102.5	4.0	3.0	0.1	0.1	1190	45.4	2.38	37.2	5.6	105.3	65.0	3.4
	6.8	0.9	2.1	1350	35.2	27.3	2.33	43.2	15.1	102.8	4.1	3.0	0.1	0.1	1350	46.0	2.28	38.3	5.9	101.6	65.0	3.5
	9.0	1.7	3.9	1190	35.4	25.9	2.2	42.9	16.2	99.5	3.7	3.0	0.1	0.1	1190	45.4	2.38	37.2	5.6	105.3	65.0	3.4
	9.0	1.7	3.9	1350	36.1	27.8	2.23	43.7	16.2	99.7	3.8	3.0	0.1	0.1	1350	46.0	2.28	38.3	5.9	101.6	65.0	3.5
100	4.5	0.1	0.3	1190	30.2	23.5	2.8	39.9	10.6	117.7	6.1	2.1	0.1	0.1	1190	45.4	2.38	37.2	5.6	105.3	65.0	3.4
	4.5	0.1	0.3	1350	30.8	25.2	2.89	40.7	10.7	118.1	6.2	2.2	0.1	0.1	1350	46.0	2.28	38.3	5.9	101.6	65.0	3.5
	6.8	0.9	2.1	1190	31.9	24.3	2.6	40.8	12.2	112.0	5.3	2.1	0.1	0.1	1190	45.4	2.38	37.2	5.6	105.3	65.0	3.4
	6.8	0.9	2.1	1350	32.5	26.0	2.67	41.6	12.2	112.3	5.4	2.2	0.1	0.1	1350	46.0	2.28	38.3	5.9	101.6	65.0	3.5
	9.0	1.7	3.8	1190	32.7	24.6	2.5	41.3	13.0	109.2	4.9	2.1	0.1	0.1	1190	45.4	2.38	37.2	5.6	105.3	65.0	3.4
	9.0	1.7	3.8	1350	33.3	26.4	2.56	42.1	13.0	109.3	5.0	2.2	0.1	0.1	1350	46.0	2.28	38.3	5.9	101.6	65.0	3.5
110	4.5	0.1	0.2	1190	27.7	22.6	3.2	38.7	8.5	127.2	7.6	1.7	0.1	0.1	1190	45.4	2.38	37.2	5.6	105.3	65.0	3.4
	4.5	0.1	0.2	1350	28.2	24.2	3.30	39.5	8.5	127.5	7.7	1.7	0.1	0.1	1350	46.0	2.28	38.3	5.9	101.6	65.0	3.5
	6.8	0.9	2.0	1190	29.2	23.1	3.0	39.4	9.7	121.6	6.7	1.7	0.1	0.1	1190	45.4	2.38	37.2	5.6	105.3	65.0	3.4
	6.8	0.9	2.0	1350	29.7	24.7	3.05	40.1	9.7	121.9	6.8	1.7	0.1	0.1	1350	46.0	2.28	38.3	5.9	101.6	65.0	3.5
	9.0	1.6	3.7	1190	30.0	23.4	2.9	39.8	10.4	118.8	6.2	1.7	0.1	0.1	1190	45.4	2.38	37.2	5.6	105.3	65.0	3.4
	9.0	1.6	3.7	1350	30.5	25.1	2.93	40.5	10.4	119.0	6.3	1.7	0.1	0.1	1350	46.0	2.28	38.3	5.9	101.6	65.0	3.5
120	4.5	0.1	0.1	1190	25.4	22.0	3.7	38.0	6.9	136.9	9.3	1.4	0.1	0.1	1190	45.4	2.38	37.2	5.6	105.3	65.0	3.4
	4.5	0.1	0.1	1350	25.9	23.6	3.75	38.7	6.9	137.2	9.5	1.4	0.1	0.1	1350	46.0	2.28	38.3	5.9	101.6	65.0	3.5
	6.8																					

## Performance Data - HZ H/V/D 048 (Full Load), With vFlow®

### 1650 CFM Nominal (Rated) Airflow Heating, 1550 CFM Nominal (Rated) Airflow Cooling

Performance capacities shown in thousands of Btuh

EWT °F	GPM	WPD		COOLING - EAT 80/67 °F								GPM	WPD			HEATING - 70°F							
				CFM	TC	SC	kW	HR	EER	LWT	HWC					CFM	HC	kW	HE	COP	LAT	LWT	HWC
		PSI	FT	CFM	TC	SC	kW	HR	EER	LWT	HWC		PSI	FT	CFM	HC	kW	HE	COP	LAT	LWT	HWC	
20	2.5	0.1	0.2	1360	54.0	33.1	2.3	61.6	23.9	70.0	2.3	12.0	4.1	9.4	1450	31.4	3.17	20.9	2.9	90.1	16.5	3.3	
	2.5	0.1	0.2	1550	54.9	35.6	2.34	62.9	23.5	70.0	2.3	12.0	4.1	9.4	1650	31.9	3.07	21.4	3.0	87.9	16.4	3.3	
30	3.1	0.1	0.2	1360	54.0	33.1	2.3	61.6	23.9	70.0	2.3	6.0	0.9	2.1	1450	34.7	3.16	24.2	3.2	92.2	21.9	3.4	
	3.1	0.1	0.2	1550	54.9	35.6	2.34	62.9	23.5	70.0	2.3	6.0	0.9	2.1	1650	35.3	3.06	24.8	3.4	89.8	21.7	3.5	
	3.1	0.1	0.2	1360	54.0	33.1	2.3	61.6	23.9	70.0	2.3	9.0	2.1	4.9	1450	36.2	3.16	25.7	3.4	93.1	24.3	3.5	
	3.1	0.1	0.2	1550	54.9	35.6	2.34	62.9	23.5	70.0	2.3	9.0	2.1	4.9	1650	36.8	3.06	26.3	3.5	90.6	24.1	3.5	
	3.1	0.1	0.2	1360	54.0	33.1	2.3	61.6	23.9	70.0	2.3	12.0	3.8	8.8	1450	37.1	3.16	26.5	3.4	93.7	25.6	3.5	
	3.1	0.1	0.2	1550	54.9	35.6	2.34	62.9	23.5	70.0	2.3	12.0	3.8	8.8	1650	37.6	3.06	27.2	3.6	91.1	25.5	3.6	
40	4.1	0.2	0.5	1360	54.0	33.1	2.3	61.6	23.9	70.0	2.3	6.0	0.8	1.8	1450	39.9	3.18	29.2	3.7	95.5	30.3	3.6	
	4.2	0.2	0.5	1550	54.9	35.6	2.34	62.9	23.5	70.0	2.3	6.0	0.8	1.8	1650	40.5	3.08	30.0	3.9	92.7	30.0	3.7	
	4.1	0.2	0.5	1360	54.0	33.1	2.3	61.6	23.9	70.0	2.3	9.0	2.0	4.6	1450	41.7	3.21	30.9	3.8	96.6	33.1	3.7	
	4.2	0.2	0.5	1550	54.9	35.6	2.34	62.9	23.5	70.0	2.3	9.0	2.0	4.6	1650	42.3	3.11	31.7	4.0	93.8	32.9	3.8	
	4.1	0.2	0.5	1360	54.0	33.1	2.3	61.6	23.9	70.0	2.3	12.0	3.6	8.4	1450	42.7	3.22	31.8	3.9	97.3	34.7	3.8	
	4.2	0.2	0.5	1550	54.9	35.6	2.34	62.9	23.5	70.0	2.3	12.0	3.6	8.4	1650	43.3	3.12	32.7	4.1	94.3	34.6	3.9	
50	6.0	0.7	1.7	1360	54.0	33.2	2.3	61.7	23.6	70.6	2.3	6.0	0.7	1.7	1450	45.0	3.26	34.0	4.0	98.8	38.7	3.9	
	6.0	0.7	1.7	1550	54.9	35.7	2.37	63.0	23.2	71.0	2.3	6.0	0.7	1.7	1650	45.7	3.16	34.9	4.2	95.7	38.4	4.0	
	6.2	0.8	1.8	1360	54.0	33.1	2.3	61.6	23.9	70.0	2.3	9.0	1.9	4.3	1450	47.2	3.30	36.0	4.2	100.1	42.0	4.1	
	6.3	0.8	1.9	1550	54.9	35.6	2.34	62.9	23.5	70.0	2.3	9.0	1.9	4.3	1650	47.9	3.20	37.0	4.4	96.9	41.8	4.1	
	6.2	0.8	1.8	1360	54.0	33.1	2.3	61.6	23.9	70.0	2.3	12.0	3.5	8.0	1450	48.3	3.33	37.1	4.2	100.9	43.8	4.1	
	6.3	0.8	1.9	1550	54.9	35.6	2.34	62.9	23.5	70.0	2.3	12.0	3.5	8.0	1650	49.1	3.23	38.1	4.5	97.5	43.7	4.2	
60	6.0	0.7	1.6	1360	53.1	33.6	2.5	61.6	21.1	80.5	2.9	6.0	0.7	1.6	1450	50.2	3.37	38.8	4.4	102.1	47.1	4.3	
	6.0	0.7	1.6	1550	54.0	36.1	2.61	62.9	20.7	81.0	2.9	6.0	0.7	1.6	1650	51.0	3.27	39.8	4.6	98.6	46.7	4.4	
	9.0	1.8	4.2	1360	53.9	33.4	2.4	61.8	22.9	73.7	2.4	9.0	1.8	4.2	1450	52.7	3.44	41.0	4.5	103.6	50.9	4.4	
	9.0	1.8	4.2	1550	54.8	36.0	2.44	63.1	22.5	74.0	2.5	9.0	1.8	4.2	1650	53.5	3.33	42.1	4.7	100.0	50.6	4.5	
	12.0	3.4	7.8	1360	54.0	33.1	2.3	61.6	23.8	70.3	2.3	12.0	3.4	7.8	1450	54.0	3.48	42.2	4.5	104.5	53.0	4.5	
	12.0	3.4	7.8	1550	54.9	35.6	2.35	63.0	23.4	70.5	2.3	12.0	3.4	7.8	1650	54.8	3.37	43.3	4.8	100.8	52.8	4.6	
70	6.0	0.7	1.5	1360	51.0	33.0	2.8	60.4	18.3	90.1	3.6	6.0	0.7	1.5	1450	55.5	3.52	43.5	4.6	105.4	55.5	4.6	
	6.0	0.7	1.5	1550	51.9	35.5	2.88	61.7	18.0	90.6	3.7	6.0	0.7	1.5	1650	56.3	3.41	44.7	4.8	101.6	55.1	4.7	
	9.0	1.8	4.0	1360	52.6	33.5	2.6	61.3	20.2	83.6	3.1	9.0	1.8	4.0	1450	58.2	3.60	46.0	4.7	107.2	59.8	4.9	
	9.0	1.8	4.0	1550	53.5	36.0	2.69	62.7	19.9	83.9	3.1	9.0	1.8	4.0	1650	59.1	3.49	47.2	5.0	103.2	59.5	5.0	
	12.0	3.3	7.6	1360	53.2	33.6	2.5	61.6	21.2	80.3	2.8	12.0	3.3	7.6	1450	59.7	3.64	47.3	4.8	108.1	62.1	5.0	
	12.0	3.3	7.6	1550	54.1	36.1	2.60	63.0	20.8	80.5	2.9	12.0	3.3	7.6	1650	60.6	3.53	48.6	5.0	104.0	61.9	5.1	
80	6.0	0.7	1.5	1360	48.1	31.8	3.1	58.6	15.7	99.5	4.5	6.0	0.7	1.5	1450	60.7	3.67	48.2	4.8	108.8	63.9	5.1	
	6.0	0.7	1.5	1550	49.0	34.2	3.18	59.8	15.4	99.9	4.6	6.0	0.7	1.5	1650	61.6	3.56	49.5	5.1	104.6	63.5	5.2	
	9.0	1.7	4.0	1360	50.1	32.7	2.9	59.9	17.5	93.3	3.8	6.5	0.8	1.9	1450	61.6	3.70	49.0	4.9	109.4	65.0	5.2	
	9.0	1.7	4.0	1550	51.0	35.1	2.97	61.1	17.2	93.6	3.9	6.7	0.9	2.1	1650	62.6	3.59	50.3	5.1	105.1	65.0	5.3	
	12.0	3.2	7.5	1360	51.1	33.0	2.8	60.4	18.4	90.1	3.6	6.5	0.8	1.9	1450	61.6	3.70	49.0	4.9	109.4	65.0	5.2	
	12.0	3.2	7.5	1550	51.9	35.5	2.87	61.7	18.1	90.3	3.6	6.7	0.9	2.1	1650	62.6	3.59	50.3	5.1	105.1	65.0	5.3	
90	6.0	0.7	1.5	1360	44.9	30.2	3.4	56.5	13.2	108.8	4.8	3.9	0.1	0.2	1450	61.6	3.70	49.0	4.9	109.4	65.0	5.2	
	6.0	0.7	1.5	1550	45.7	32.5	3.52	57.7	13.0	109.2	4.9	4.0	0.1	0.2	1650	62.6	3.59	50.3	5.1	105.1	65.0	5.3	
	9.0	1.7	3.9	1360	47.1	31.3	3.2	57.9	14.8	102.9	4.5	3.9	0.1	0.2	1450	61.6	3.70	49.0	4.9	109.4	65.0	5.2	
	9.0	1.7	3.9	1550	47.9	33.6	3.29	59.1	14.6	103.1	4.6	4.0	0.1	0.2	1650	62.6	3.59	50.3	5.1	105.1	65.0	5.3	
	12.0	3.2	7.4	1360	48.1	31.8	3.1	58.5	15.7	99.8	5.6	3.9	0.1	0.2	1450	61.6	3.70	49.0	4.9	109.4	65.0	5.2	
	12.0	3.2	7.4	1550	49.0	34.2	3.18	59.8	15.4	100.0	5.7	4.0	0.1	0.2	1650	62.6	3.59	50.3	5.1	105.1	65.0	5.3	
100	6.0	0.6	1.5	1360	41.7	28.6	3.8	54.6	11.1	118.2	5.9	2.8	0.1	0.2	1450	61.6	3.70	49.0	4.9	109.4	65.0	5.2	
	6.0	0.6	1.5	1550	42.5	30.8	3.91	55.8	10.9	118.6	6.0	2.9	0.1	0.2	1650	62.6	3.59	50.3	5.1	105.1	65.0	5.3	
	9.0	1.7	3.8	1360	43.7	29.6	3.5	55.8	12.4	112.4	5.6	2.8	0.1	0.2	1450	61.6	3.70	49.0	4.9	109.4	65.0	5.2	
	9.0	1.7	3.8	1550	44.5	31.8	3.65	57.0	12.2	112.7	5.7	2.9	0.1	0.2	1650	62.6	3.59	50.3	5.1	105.1	65.0	5.3	
	12.0	3.2	7.3	1360	44.8	30.1	3.4	56.4	13.2	109.4	6.8	2.8	0.1	0.2	1450	61.6	3.70	49.0	4.9	109.4	65.0	5.2	
	12.0	3.2	7.3	1550	45.6	32.4	3.53	57.6	12.9	109.6	7.0	2.9	0.1	0.2	1650	62.6	3.59	50.3	5.1	105.1	65.0	5.3	
110	6.0	0.6	1.4	1360	38.9	27.3	4.2	53.4	9.2	127.8	7.3	2.2	0.1	0.2	1450	61.6	3.70	49.0	4.9	109.4	65.0	5.2	
	6.0	0.6	1.4	1550	39.5	29.3	4.38	54.5	9.0	128.2	7.4	2.2	0.1	0.2	1650	62.6	3.59	50.3	5.1	105.1	65.0	5.3	
	9.0	1.6	3.7	1360	40.6	28.0	3.9	54.0	10.3	122.0	6.8	2.2	0.1	0.2	1450	61.6	3.70	49.0	4.9	109.4	65.0	5.2	
	9.0	1.6	3.7	1550	41.3	30.2	4.09	55.2	10.1	122.3	7.0	2.2	0.1	0.2	1650	62.6	3.59	50.3	5.1	105.1	65.0	5.3	
	12.0	3.1	7.2	1360	41.5	28.5	3.8	54.5	10.9	119.1	8.3	2.2	0.1	0.2	1450	61.6	3.70	49.0	4.9	109.4	65.0	5.2	
	12.0	3.1	7.2	1550	42.2	30.6	3.94	55.7	10.7	119.3	8.4	2.2	0.1	0.2	1650	62.6	3.59	50.3	5.1	105.1	65.0	5.3	
120	6.0	0.6	1.3	1360	36.8	26.6	4.8	53.2	7.7	137.7	8.8	1.8	0.1	0.2	1450	61.6	3.70	49.0	4.9	109.4	65.0	5.2	
	6.0	0.6	1.3	1550	37.4	28.6	4.96	54.3	7.5	138.1	9.0	1.8	0.1	0.2	1650	62.6	3.59	50.3	5.1	105.1			

# Performance Data – HZ H/V/D 060 (Part Load), With vFlow®

## 1650 CFM Nominal (Rated) Airflow Heating, 1500 CFM Nominal (Rated) Airflow Cooling

Performance capacities shown in thousands of Btuh

EWT °F	GPM		WPD		COOLING - EAT 80/67 °F								GPM		WPD		HEATING - 70°F							
					CFM	TC	SC	kW	HR	EER	LWT	HWC					CFM	HC	kW	HE	COP	LAT	LWT	HWC
20	2.4	0.1	0.1	1360	53.8	37.2	1.8	59.9	29.8	70.0	1.8	12.0	5.2	11.9	1450	28.2	2.87	18.7	2.9	88.0	16.9	3.1		
	2.4	0.1	0.1	1500	54.8	39.9	1.84	61.1	29.9	70.0	1.8	12.0	5.2	11.9	1650	28.6	2.75	19.3	3.1	86.1	16.8	3.1		
30	3.0	0.1	0.1	1360	53.8	37.2	1.8	59.9	29.8	70.0	1.8	6.0	0.9	2.1	1450	31.7	2.88	22.1	3.2	90.2	22.6	3.1		
	3.1	0.1	0.1	1500	54.8	39.9	1.84	61.1	29.9	70.0	1.8	6.0	0.9	2.1	1650	32.2	2.76	22.7	3.4	88.0	22.4	3.2		
	3.0	0.1	0.1	1360	53.8	37.2	1.8	59.9	29.8	70.0	1.8	9.0	2.5	5.7	1450	33.1	2.89	23.5	3.4	91.1	24.8	3.2		
	3.1	0.1	0.1	1500	54.8	39.9	1.84	61.1	29.9	70.0	1.8	9.0	2.5	5.7	1650	33.6	2.77	24.1	3.6	88.8	24.6	3.2		
	3.0	0.1	0.1	1360	53.8	37.2	1.8	59.9	29.8	70.0	1.8	12.0	4.1	9.6	1450	33.9	2.89	24.2	3.4	91.6	26.0	3.2		
40	4.0	0.1	0.1	1500	54.8	39.9	1.84	61.1	29.9	70.0	1.8	12.0	4.1	9.6	1650	34.4	2.77	24.9	3.6	89.3	25.8	3.2		
	4.0	0.1	0.1	1360	53.8	37.2	1.8	59.9	29.8	70.0	1.8	6.0	0.5	1.1	1450	37.0	2.91	27.3	3.7	93.6	30.9	3.2		
	4.1	0.1	0.2	1500	54.8	39.9	1.84	61.1	29.9	70.0	1.8	6.0	0.5	1.1	1650	37.6	2.79	28.0	3.9	91.1	30.7	3.3		
	4.0	0.1	0.2	1360	53.8	37.2	1.8	59.9	29.8	70.0	1.8	9.0	1.9	4.3	1450	38.8	2.92	29.0	3.9	94.8	33.6	3.3		
	4.1	0.1	0.2	1500	54.8	39.9	1.84	61.1	29.9	70.0	1.8	9.0	1.9	4.3	1650	39.4	2.80	29.8	4.1	92.1	33.4	3.4		
50	4.0	0.1	0.2	1360	53.8	37.2	1.8	59.9	29.8	70.0	1.8	12.0	3.4	7.9	1450	39.8	2.93	30.0	4.0	95.4	35.0	3.3		
	4.1	0.1	0.2	1500	54.8	39.9	1.84	61.1	29.9	70.0	1.8	12.0	3.4	7.9	1650	40.4	2.81	30.8	4.2	92.7	34.9	3.4		
	6.0	0.2	0.6	1360	53.7	37.2	1.8	59.9	29.6	70.0	1.8	6.0	0.2	0.6	1450	42.5	2.95	32.6	4.2	97.1	39.1	3.4		
	6.0	0.2	0.6	1500	54.8	39.8	1.85	61.1	29.7	70.4	1.8	6.0	0.2	0.6	1650	43.1	2.82	33.5	4.5	94.2	38.8	3.5		
	6.0	0.2	0.5	1360	53.8	37.2	1.8	59.9	29.8	70.0	1.8	9.0	1.5	3.5	1450	44.7	2.96	34.7	4.4	98.5	42.3	3.5		
60	6.1	0.3	0.7	1500	54.8	39.9	1.84	61.1	29.9	70.0	1.8	9.0	1.5	3.5	1650	45.3	2.84	35.7	4.7	95.4	42.1	3.5		
	6.0	0.2	0.5	1360	53.8	37.2	1.8	59.9	29.8	70.0	1.8	12.0	3.0	6.9	1450	45.9	2.97	35.9	4.5	99.3	44.0	3.5		
	6.1	0.3	0.7	1500	54.8	39.9	1.84	61.1	29.9	70.0	1.8	12.0	3.0	6.9	1650	46.6	2.85	36.9	4.8	96.1	43.9	3.6		
	6.0	0.2	0.4	1360	51.4	36.3	2.1	58.5	24.8	79.5	2.4	6.0	0.2	0.4	1450	48.1	2.99	37.9	4.7	100.7	47.4	3.6		
	6.0	0.2	0.4	1500	52.4	38.9	2.11	59.6	24.8	79.9	2.5	6.0	0.2	0.4	1650	48.8	2.86	39.0	5.0	97.4	47.0	3.7		
70	9.0	1.4	3.1	1360	53.0	36.9	1.9	59.5	28.0	73.2	2.0	9.0	1.4	3.1	1450	50.6	3.01	40.4	4.9	102.3	51.0	3.7		
	9.0	1.4	3.1	1500	54.1	39.5	1.93	60.6	28.1	73.5	2.0	9.0	1.4	3.1	1650	51.4	2.89	41.5	5.2	98.8	50.8	3.8		
	12.0	2.7	6.3	1360	53.8	37.2	1.8	59.9	29.7	70.0	1.8	12.0	2.7	6.3	1450	52.1	3.02	41.7	5.0	103.2	53.0	3.8		
	12.0	2.7	6.3	1500	54.8	39.9	1.84	61.1	29.8	70.2	1.8	12.0	2.7	6.3	1650	52.8	2.90	42.9	5.3	99.6	52.8	3.8		
	6.0	0.2	0.4	1360	48.6	35.4	2.4	56.7	20.4	88.9	3.3	6.0	0.2	0.4	1450	53.6	3.04	43.3	5.2	104.2	55.6	3.8		
80	6.0	0.2	0.4	1500	49.6	37.9	2.42	57.8	20.4	89.3	3.3	6.0	0.2	0.4	1650	54.4	2.91	44.5	5.5	100.5	55.2	3.9		
	9.0	1.3	3.0	1360	50.5	36.0	2.2	57.9	23.2	82.9	2.7	9.0	1.3	3.0	1450	56.5	3.07	46.0	5.4	106.1	59.8	4.0		
	9.0	1.3	3.0	1500	51.5	38.6	2.21	59.0	23.3	83.1	2.7	9.0	1.3	3.0	1650	57.3	2.94	47.3	5.7	102.2	59.5	4.1		
	12.0	2.6	6.0	1360	51.4	36.3	2.1	58.5	24.8	79.7	2.4	12.0	2.6	6.0	1450	58.1	3.08	47.5	5.5	107.1	62.1	4.1		
	12.0	2.6	6.0	1500	52.4	38.9	2.11	59.6	24.8	79.9	2.5	12.0	2.6	6.0	1650	58.9	2.96	48.8	5.8	103.1	61.9	4.2		
90	6.0	0.2	0.6	1360	45.6	34.3	2.7	54.9	16.7	98.3	4.3	6.0	0.3	0.6	1450	59.1	3.10	48.5	5.6	107.7	63.8	4.1		
	6.0	0.2	0.6	1500	46.5	36.7	2.78	56.0	16.7	98.7	4.4	6.0	0.3	0.6	1650	59.9	2.97	49.8	5.9	103.6	63.4	4.2		
	9.0	1.3	3.1	1360	47.5	35.0	2.5	56.1	19.0	92.5	3.6	6.6	0.5	1.1	1450	60.2	3.11	49.5	5.7	108.4	65.0	4.2		
	9.0	1.3	3.1	1500	48.5	37.5	2.55	57.2	19.0	92.7	3.7	6.6	0.5	1.2	1650	61.0	2.98	50.8	6.0	104.2	65.0	4.3		
	12.0	2.6	5.9	1360	48.5	35.3	2.4	56.7	20.3	89.4	3.3	6.6	0.5	1.1	1450	60.2	3.11	49.5	5.7	108.4	65.0	4.2		
100	12.0	2.6	5.9	1500	49.5	37.8	2.44	57.8	20.3	89.6	3.4	6.6	0.5	1.2	1650	61.0	2.98	50.8	6.0	104.2	65.0	4.3		
	6.0	0.3	0.7	1360	42.4	33.0	3.1	53.1	13.6	107.7	5.5	4.0	0.2	0.5	1450	60.2	3.11	49.5	5.7	108.4	65.0	4.2		
	6.0	0.3	0.7	1500	43.3	35.3	3.18	54.1	13.6	108.0	5.6	4.1	0.2	0.5	1650	61.0	2.98	50.8	6.0	104.2	65.0	4.3		
	9.0	1.4	3.2	1360	44.4	33.8	2.9	54.2	15.4	102.0	4.7	4.0	0.2	0.5	1450	60.2	3.11	49.5	5.7	108.4	65.0	4.2		
	9.0	1.4	3.2	1500	45.2	36.2	2.93	55.2	15.4	102.3	4.8	4.1	0.2	0.5	1650	61.0	2.98	50.8	6.0	104.2	65.0	4.3		
110	12.0	2.6	6.0	1360	45.4	34.2	2.8	54.8	16.4	99.1	4.4	4.0	0.2	0.5	1450	60.2	3.11	49.5	5.7	108.4	65.0	4.2		
	12.0	2.6	6.0	1500	46.2	36.6	2.81	55.8	16.5	99.3	4.4	4.1	0.2	0.5	1650	61.0	2.98	50.8	6.0	104.2	65.0	4.3		
	6.0	0.3	0.8	1360	39.4	31.6	3.6	51.5	11.1	117.2	6.9	2.8	0.1	0.2	1450	60.2	3.11	49.5	5.7	108.4	65.0	4.2		
	6.0	0.3	0.8	1500	40.2	33.9	3.62	52.5	11.1	117.5	7.0	2.9	0.1	0.2	1650	61.0	2.98	50.8	6.0	104.2	65.0	4.3		
	9.0	1.4	3.2	1360	41.2	32.5	3.3	52.4	12.5	111.7	6.0	2.8	0.1	0.2	1450	60.2	3.11	49.5	5.7	108.4	65.0	4.2		
120	9.0	1.4	3.2	1500	42.0	34.7	3.36	53.4	12.5	111.9	6.1	2.9	0.1	0.2	1650	61.0	2.98	50.8	6.0	104.2	65.0	4.3		
	12.0	2.6	6.0	1360	42.1	32.9	3.2	52.9	13.3	108.8	5.6	2.8	0.1	0.2	1450	60.2	3.11	49.5	5.7	108.4	65.0	4.2		
	12.0	2.6	6.0	1500	43.0	35.2	3.23	54.0	13.3	109.0	5.7	2.9	0.1	0.2	1650	61.0	2.98	50.8	6.0	104.2	65.0	4.3		
	6.0	0.3	0.6	1360	36.7	30.2	4.0	50.4	9.1	126.8	8.5	2.2	0.1	0.1	1450	60.2	3.11	49.5	5.7	108.4	65.0	4.2		
	6.0	0.3	0.6	1500	37.4	32.4	4.09	51.3	9.1	127.1	8.7	2.3	0.1	0.1	1650	61.0	2.98	50.8	6.0	104.2	65.0	4.3		

Interpolation is permissible, extrapolation is not. All performance data is based on the lower voltage of dual voltage units.  
Performance stated is at the rated power supply, performance may vary as the power supply varies from the rated.  
Table is with entering air of 80°F DB and 67°F WB in cooling, and 70°F DB in heating.  
AHRI/ISO certified conditions are 80.6°F DB and 66.2°F WB in cooling and 68°F DB in heating.  
Table does not reflect fan or pump power corrections for AHRI/ISO conditions.  
See performance correction tables for operating conditions other than those listed above. See performance data selection notes for operation in the shaded areas.  
Operation below 40°F EWT is based on a 15% methanol antifreeze solution.  
Operation below 60°F EWT requires optional extended range insulated water and refrigerant circuits to avoid condensation within the unit cabinet.



## Performance Data - HZ H/V/D 060 (Full Load), With vFlow<sup>®</sup>

### 2050 CFM Nominal (Rated) Airflow Heating, 1850 CFM Nominal (Rated) Airflow Cooling

Performance capacities shown in thousands of Btu/h

EWT °F	GPM		WPD		COOLING - EAT 80/67 °F								GPM		WPD		HEATING - 70°F							
					CFM	TC	SC	kW	HR	EER	LWT	HWC					CFM	HC	kW	HE	COP	LAT	LWT	HWC
20	3.3	0.2	0.4		1630	73.0	48.1	3.0	83.2	24.2	70.0	2.7	15.0	7.3	16.8	1800	42.8	3.89	29.8	3.2	92.0	16.0	3.8	
	3.4	0.2	0.2		1850	74.3	51.7	3.13	85.0	23.7	70.0	2.8	15.0	7.3	16.8	2050	43.4	3.77	30.6	3.4	89.6	15.9	3.8	
30	4.2	0.1	0.2		1630	73.0	48.1	3.0	83.2	24.2	70.0	2.7	7.5	1.7	3.9	1800	46.9	3.95	33.6	3.5	94.1	21.0	3.9	
	4.2	0.1	0.2		1850	74.3	51.7	3.13	85.0	23.7	70.0	2.8	7.5	1.7	3.9	2050	47.6	3.82	34.5	3.6	91.5	20.8	4.0	
	4.2	0.1	0.1		1630	73.0	48.1	3.0	83.2	24.2	70.0	2.7	11.3	3.7	8.6	1800	49.1	3.98	35.8	3.6	95.3	23.6	4.0	
	4.2	0.1	0.1		1850	74.3	51.7	3.13	85.0	23.7	70.0	2.8	11.3	3.7	8.6	2050	49.9	3.86	36.7	3.8	92.5	23.5	4.1	
	4.2	0.1	0.2		1630	73.0	48.1	3.0	83.2	24.2	70.0	2.7	15.0	6.1	14.1	1800	50.4	4.00	36.9	3.7	95.9	25.1	4.0	
	4.2	0.1	0.2		1850	74.3	51.7	3.13	85.0	23.7	70.0	2.8	15.0	6.1	14.1	2050	51.2	3.88	37.9	3.9	93.1	24.9	4.1	
40	5.5	0.3	0.6		1630	73.0	48.1	3.0	83.2	24.2	70.0	2.7	7.5	1.2	2.7	1800	53.9	4.06	40.2	3.9	97.7	29.3	4.2	
	5.7	0.3	0.2		1850	74.3	51.7	3.13	85.0	23.7	70.0	2.8	7.5	1.2	2.7	2050	54.7	3.94	41.3	4.1	94.7	29.0	4.2	
	5.7	0.3	0.6		1630	73.0	48.1	3.0	83.2	24.2	70.0	2.7	11.3	3.0	7.0	1800	56.7	4.12	42.8	4.0	99.2	32.4	4.3	
	5.7	0.3	0.8		1850	74.3	51.7	3.13	85.0	23.7	70.0	2.8	11.3	3.0	7.0	2050	57.6	3.99	44.0	4.2	96.0	32.2	4.4	
	5.5	0.3	0.6		1630	73.0	48.1	3.0	83.2	24.2	70.0	2.7	15.0	5.3	12.2	1800	58.3	4.15	44.3	4.1	100.0	34.1	4.3	
	5.7	0.3	0.8		1850	74.3	51.7	3.13	85.0	23.7	70.0	2.8	15.0	5.3	12.2	2050	59.2	4.02	45.5	4.3	96.7	33.9	4.4	
50	7.5	0.9	2.0		1630	72.4	47.8	3.1	82.8	23.5	72.1	2.8	7.5	0.9	2.0	1800	61.1	4.21	46.9	4.3	101.5	37.5	4.5	
	7.5	0.9	2.0		1850	73.6	51.4	3.20	84.5	23.0	72.5	2.9	7.5	0.9	2.0	2050	62.1	4.08	48.2	4.5	98.0	37.2	4.6	
	8.3	1.2	2.8		1630	73.0	48.1	3.0	83.2	24.2	70.0	2.7	11.3	2.6	6.0	1800	64.5	4.28	50.0	4.4	103.2	41.1	4.6	
	8.5	1.3	3.0		1850	74.3	51.7	3.13	85.0	23.7	70.0	2.8	11.3	2.6	6.0	2050	65.5	4.15	51.3	4.6	99.6	40.9	4.7	
	8.3	1.2	2.8		1630	73.0	48.1	3.0	83.2	24.2	70.0	2.7	15.0	4.7	10.8	1800	66.3	4.32	51.7	4.5	104.1	43.1	4.7	
	8.5	1.3	3.0		1850	74.3	51.7	3.13	85.0	23.7	70.0	2.8	15.0	4.7	10.8	2050	67.3	4.19	53.0	4.7	100.4	42.9	4.8	
60	7.5	0.7	1.7		1630	69.5	46.7	3.4	80.9	20.7	81.6	3.5	7.5	0.7	1.7	1800	68.5	4.37	53.6	4.6	105.2	45.7	4.9	
	7.5	0.7	1.7		1850	70.7	50.3	3.47	82.6	20.4	82.0	3.6	7.5	0.7	1.7	2050	69.5	4.24	55.1	4.8	101.4	45.3	5.0	
	11.3	2.4	5.4		1630	71.7	47.6	3.1	82.3	22.8	74.6	3.0	11.3	2.4	5.4	1800	72.3	4.46	57.1	4.7	107.2	49.8	5.1	
	11.3	2.4	5.4		1850	73.0	51.1	3.26	84.1	22.4	75.0	3.1	11.3	2.4	5.4	2050	73.4	4.33	58.6	5.0	103.2	49.6	5.2	
	15.0	4.3	10.0		1630	72.7	48.0	3.1	83.0	23.8	71.1	2.8	15.0	4.3	10.0	1800	74.4	4.52	59.0	4.8	108.3	52.1	5.2	
	15.0	4.3	10.0		1850	74.0	51.6	3.16	84.8	23.4	71.3	2.8	15.0	4.3	10.0	2050	75.5	4.38	60.6	5.1	104.1	51.9	5.3	
70	7.5	0.7	1.7		1630	66.1	45.5	3.7	78.6	18.0	91.0	4.4	7.5	0.7	1.7	1800	75.8	4.55	60.3	4.9	109.0	53.9	5.3	
	7.5	0.7	1.7		1850	67.3	48.9	3.81	80.3	17.7	91.4	4.5	7.5	0.7	1.7	2050	77.0	4.41	61.9	5.1	104.8	53.5	5.4	
	11.3	2.3	5.2		1630	68.6	46.4	3.4	80.3	20.0	84.2	3.8	11.3	2.3	5.2	1800	80.1	4.67	64.2	5.0	111.2	58.6	5.6	
	11.3	2.3	5.2		1850	69.8	49.9	3.56	82.0	19.6	84.6	3.8	11.3	2.3	5.2	2050	81.3	4.52	65.9	5.3	106.7	58.3	5.7	
	15.0	4.1	9.5		1630	69.9	46.9	3.3	81.1	21.0	80.8	3.5	15.0	4.1	9.5	1800	82.4	4.73	66.3	5.1	112.4	61.2	5.7	
	15.0	4.1	9.5		1850	71.1	50.4	3.44	82.8	20.6	81.0	3.5	15.0	4.1	9.5	2050	83.7	4.59	68.0	5.3	107.8	60.9	5.8	
80	7.5	0.8	1.8		1630	62.5	44.1	4.0	76.2	15.4	100.3	5.5	7.5	0.8	1.8	1800	83.1	4.75	66.9	5.1	112.8	62.2	5.8	
	7.5	0.8	1.8		1850	63.5	47.5	4.19	77.8	15.1	100.8	5.6	7.5	0.8	1.8	2050	84.4	4.61	68.7	5.4	108.1	61.7	5.9	
	11.3	2.2	5.2		1630	65.1	45.1	3.8	77.9	17.2	93.8	4.7	9.3	1.4	3.3	1800	86.0	4.84	69.5	5.2	114.3	65.0	6.0	
	11.3	2.2	5.2		1850	66.2	48.5	3.91	79.6	16.9	94.1	4.8	9.3	1.4	3.3	2050	87.3	4.69	71.3	5.5	109.4	65.0	6.1	
	15.0	4.1	9.4		1630	66.4	45.6	3.6	78.7	18.2	90.5	4.3	9.3	1.4	3.3	1800	86.0	4.84	69.5	5.2	114.3	65.0	6.0	
	15.0	4.1	9.4		1850	67.5	49.0	3.78	80.4	17.9	90.7	4.4	9.3	1.4	3.3	2050	87.3	4.69	71.3	5.5	109.4	65.0	6.1	
90	7.5	0.8	2.0		1630	58.7	42.6	4.5	74.0	13.1	109.7	6.7	5.6	0.2	0.4	1800	86.0	4.84	69.5	5.2	114.3	65.0	6.0	
	7.5	0.8	2.0		1850	59.8	45.8	4.65	75.6	12.9	110.2	6.8	5.6	0.2	0.5	2050	87.3	4.69	71.3	5.5	109.4	65.0	6.1	
	11.3	2.3	5.2		1630	61.3	43.7	4.2	75.5	14.7	103.4	5.8	5.6	0.2	0.4	1800	86.0	4.84	69.5	5.2	114.3	65.0	6.0	
	11.3	2.3	5.2		1850	62.3	47.0	4.33	77.1	14.4	103.7	5.9	5.6	0.2	0.5	2050	87.3	4.69	71.3	5.5	109.4	65.0	6.1	
	15.0	4.0	9.3		1630	62.6	44.2	4.0	76.3	15.5	100.2	5.4	5.6	0.2	0.4	1800	86.0	4.84	69.5	5.2	114.3	65.0	6.0	
	15.0	4.0	9.3		1850	63.7	47.5	4.18	77.9	15.2	100.4	5.5	5.6	0.2	0.5	2050	87.3	4.69	71.3	5.5	109.4	65.0	6.1	
100	7.5	0.9	2.0		1630	55.2	41.1	5.0	72.3	11.0	119.3	8.1	4.0	0.1	0.2	1800	86.0	4.84	69.5	5.2	114.3	65.0	6.0	
	7.5	0.9	2.0		1850	56.2	44.2	5.18	73.9	10.8	119.7	8.3	4.0	0.1	0.2	2050	87.3	4.69	71.3	5.5	109.4	65.0	6.1	
	11.3	2.3	5.2		1630	57.5	42.1	4.6	73.4	12.4	113.0	7.1	4.0	0.1	0.2	1800	86.0	4.84	69.5	5.2	114.3	65.0	6.0	
	11.3	2.3	5.2		1850	58.5	45.3	4.82	75.0	12.1	113.3	7.3	4.0	0.1	0.2	2050	87.3	4.69	71.3	5.5	109.4	65.0	6.1	
	15.0	4.0	9.3		1630	58.8	42.6	4.5	74.0	13.1	109.9	6.7	4.0	0.1	0.2	1800	86.0	4.84	69.5	5.2	114.3	65.0	6.0	
	15.0	4.0	9.3		1850	59.8	45.9	4.65	75.6	12.9	110.1	6.8	4.0	0.1	0.2	2050	87.3	4.69	71.3	5.5	109.4	65.0	6.1	
110	7.5	0.8	1.8		1630	52.2	39.6	5.6	71.4	9.3	129.0	9.8	3.1	0.1	0.1	1800	86.0	4.84	69.5	5.2	114.3	65.0	6.0	
	7.5	0.8	1.8		1850	53.1	42.6	5.80	72.9	9.2	129.4	10.0	3.1	0.1	0.1	2050	87.3	4.69	71.3	5.5	109.4	65.0	6.1	
	11.3	2.2	5.1		1630	54.1	40.6	5.2	71.9	10.4	122.7	8.7	3.1	0.1	0.1	1800	86.0	4.84	69.5	5.2	114.3	65.0	6.0	
	11.3	2.2	5.1		1850	55.0	43.6	5.39	73.4	10.2	123.1	8.8	3.1	0.1	0.1	2050	87.3	4.69	71.3	5.5	109.4	65.0	6.1	
	15.0	4.0	9.2		1630	55.2	41.1	5.0	72.3	11.0	119.6	8.2	3.1	0.1	0.1	1800	86.0	4.84	69.5	5.2	114.3	65.0	6.0	
	15.0	4.0	9.2		1850	56.1	44.2	5.19	73.8	10.8	119.8	8.3	3.1	0.1	0.1	2050	87.3	4.69	71.3	5.5	109.4	65.0	6.1	
120	7.5	0.6	1.3		1630	50.0	38.5	6.3	71.6	7.9	139.1	11.7	2.5	0.1	0.1	1800	86.0	4.84	69.5	5.2	114.3	65.0	6.0	
	7.5	0.6	1.3		1850	50.8	41.4	6.53																

# Performance Data - HZ H/V/D 070 (Part Load), With vFlow®

## 1650 CFM Nominal (Rated) Airflow Heating, 1550 CFM Nominal (Rated) Airflow Cooling

Performance capacities shown in thousands of Btu/h

EWT °F	GPM	WPD		COOLING - EAT 80/67 °F								WPD		HEATING - 70°F								
		PSI	FT	CFM	TC	SC	kW	HR	EER	LWT	HWC	GPM	PSI	FT	CFM	HC	kW	HE	COP	LAT	LWT	HWC
20	2.8	0.1	0.2	1360	61.8	39.2	2.3	69.5	27.2	70.0	2.6	14.0	6.5	15.1	1450	32.9	3.66	20.9	2.6	91.0	17.0	4.1
	2.8	0.1	0.2	1550	63.0	42.0	2.31	70.9	27.2	70.0	2.7	14.0	6.5	15.1	1650	33.4	3.51	21.4	2.8	88.7	16.9	4.1
30	3.5	0.1	0.2	1360	61.8	39.2	2.3	69.5	27.2	70.0	2.6	7.0	1.4	3.3	1450	37.2	3.72	24.8	2.9	93.7	22.9	4.2
	3.5	0.1	0.2	1550	63.0	42.0	2.31	70.9	27.2	70.0	2.7	7.0	1.4	3.3	1650	37.7	3.57	25.5	3.1	91.1	22.7	4.3
	3.5	0.1	0.2	1360	61.8	39.2	2.3	69.5	27.2	70.0	2.6	10.5	3.3	7.6	1450	38.7	3.75	26.3	3.0	94.7	25.0	4.2
	3.5	0.1	0.2	1550	63.0	42.0	2.31	70.9	27.2	70.0	2.7	10.5	3.3	7.6	1650	39.3	3.59	27.0	3.2	92.0	24.9	4.3
	3.5	0.1	0.2	1360	61.8	39.2	2.3	69.5	27.2	70.0	2.6	14.0	5.4	12.5	1450	39.6	3.76	27.1	3.1	95.3	26.1	4.2
	3.5	0.1	0.2	1550	63.0	42.0	2.31	70.9	27.2	70.0	2.7	14.0	5.4	12.5	1650	40.1	3.60	27.8	3.3	92.5	26.0	4.3
40	4.6	0.1	0.2	1360	61.8	39.2	2.3	69.5	27.2	70.0	2.6	7.0	0.9	2.2	1450	43.3	3.81	30.6	3.3	97.6	31.3	4.4
	4.7	0.2	0.4	1550	63.0	42.0	2.31	70.9	27.2	70.0	2.7	7.0	0.9	2.2	1650	43.9	3.65	31.4	3.5	94.6	31.0	4.5
	4.6	0.2	0.4	1360	61.8	39.2	2.3	69.5	27.2	70.0	2.6	10.5	2.6	6.1	1450	45.2	3.84	32.4	3.5	98.9	33.8	4.4
	4.7	0.2	0.4	1550	63.0	42.0	2.31	70.9	27.2	70.0	2.7	10.5	2.6	6.1	1650	45.8	3.68	33.3	3.7	95.7	33.7	4.5
	4.6	0.2	0.4	1360	61.8	39.2	2.3	69.5	27.2	70.0	2.6	14.0	4.6	10.7	1450	46.3	3.85	33.4	3.5	99.5	35.2	4.4
	4.7	0.2	0.4	1550	63.0	42.0	2.31	70.9	27.2	70.0	2.7	14.0	4.6	10.7	1650	46.9	3.69	34.3	3.7	96.3	35.1	4.5
50	7.0	0.7	1.5	1360	61.7	39.2	2.3	69.5	27.1	69.9	2.6	7.0	0.7	1.5	1450	49.4	3.90	36.3	3.7	101.5	39.6	4.7
	7.0	0.7	1.5	1550	62.9	41.9	2.32	70.8	27.1	70.2	2.7	7.0	0.7	1.5	1650	50.1	3.74	37.4	3.9	98.1	39.3	4.8
	7.0	0.6	1.5	1360	61.8	39.2	2.3	69.5	27.2	70.0	2.6	10.5	2.2	5.1	1450	51.7	3.93	38.5	3.9	103.0	42.7	4.8
	7.1	0.7	1.6	1550	63.0	42.0	2.31	70.9	27.2	70.0	2.7	10.5	2.2	5.1	1650	52.5	3.77	39.6	4.1	99.4	42.5	4.9
	7.0	0.6	1.5	1360	61.8	39.2	2.3	69.5	27.2	70.0	2.6	14.0	4.1	9.4	1450	53.0	3.95	39.7	3.9	103.8	44.3	4.8
	7.1	0.7	1.6	1550	63.0	42.0	2.31	70.9	27.2	70.0	2.7	14.0	4.1	9.4	1650	53.8	3.78	40.8	4.2	100.2	44.2	4.9
60	7.0	0.5	1.3	1360	59.1	38.1	2.6	68.0	22.7	79.4	3.2	7.0	0.5	1.3	1450	55.6	3.98	42.2	4.1	105.5	48.0	5.1
	7.0	0.5	1.3	1550	60.2	40.8	2.65	69.3	22.7	79.8	3.2	7.0	0.5	1.3	1650	56.4	3.82	43.3	4.3	101.6	47.6	5.2
	10.5	2.0	4.6	1360	60.9	38.8	2.4	69.0	25.6	73.1	2.8	10.5	2.0	4.6	1450	58.3	4.02	44.7	4.2	107.2	51.5	5.2
	10.5	2.0	4.6	1550	62.1	41.6	2.42	70.4	25.6	73.4	2.9	10.5	2.0	4.6	1650	59.1	3.86	46.0	4.5	103.2	51.2	5.3
	14.0	3.8	8.7	1360	61.8	39.2	2.3	69.5	27.1	69.9	2.7	14.0	3.8	8.7	1450	59.8	4.04	46.1	4.3	108.2	53.4	5.3
	14.0	3.8	8.7	1550	63.0	42.0	2.32	70.9	27.2	70.1	2.7	14.0	3.8	8.7	1650	60.6	3.88	47.4	4.6	104.0	53.2	5.4
70	7.0	0.5	1.3	1360	56.0	36.9	3.0	66.2	18.8	88.9	4.2	7.0	0.5	1.3	1450	61.8	4.07	48.0	4.4	109.4	56.3	5.5
	7.0	0.5	1.3	1550	57.1	39.5	3.04	67.5	18.8	89.3	4.3	7.0	0.5	1.3	1650	62.6	3.90	49.3	4.7	105.1	55.9	5.6
	10.5	1.9	4.5	1360	58.1	37.7	2.7	67.4	21.3	82.8	3.6	10.5	1.9	4.5	1450	64.8	4.12	50.9	4.6	111.4	60.3	5.7
	10.5	1.9	4.5	1550	59.2	40.3	2.78	68.7	21.3	83.1	3.7	10.5	1.9	4.5	1650	65.8	3.95	52.3	4.9	106.9	60.0	5.8
	14.0	3.6	8.3	1360	59.1	38.1	2.6	67.9	22.7	79.7	3.4	14.0	3.6	8.3	1450	66.5	4.14	52.5	4.7	112.5	62.5	5.8
	14.0	3.6	8.3	1550	60.2	40.7	2.65	69.3	22.7	79.9	3.5	14.0	3.6	8.3	1650	67.5	3.97	53.9	5.0	107.9	62.3	5.9
80	7.0	0.6	1.4	1360	52.7	35.6	3.4	64.3	15.4	98.4	5.7	7.0	0.6	1.4	1450	68.0	4.17	53.8	4.8	113.4	64.6	6.0
	7.0	0.6	1.4	1550	53.7	38.1	3.48	65.6	15.4	98.7	5.8	7.0	0.6	1.4	1650	68.9	3.99	55.3	5.1	108.7	64.2	6.1
	10.5	1.9	4.5	1360	54.8	36.4	3.1	65.5	17.5	92.5	4.9	7.2	0.7	1.6	1450	68.5	4.17	54.3	4.8	113.8	65.0	6.0
	10.5	1.9	4.5	1550	55.9	39.0	3.19	66.8	17.5	92.7	5.0	7.4	0.8	1.8	1650	69.5	4.00	55.8	5.1	109.0	65.0	6.1
	14.0	3.5	8.1	1360	55.9	36.8	3.0	66.1	18.7	89.4	4.5	7.2	0.7	1.6	1450	68.5	4.17	54.3	4.8	113.8	65.0	6.0
	14.0	3.5	8.1	1550	57.0	39.4	3.05	67.4	18.7	89.6	4.6	7.4	0.8	1.8	1650	69.5	4.00	55.8	5.1	109.0	65.0	6.1
90	7.0	0.7	1.5	1360	49.1	34.2	3.9	62.5	12.6	107.8	7.5	4.3	0.3	0.6	1450	68.5	4.17	54.3	4.8	113.8	65.0	6.0
	7.0	0.7	1.5	1550	50.1	36.6	3.98	63.7	12.6	108.2	7.6	4.5	0.3	0.6	1650	69.5	4.00	55.8	5.1	109.0	65.0	6.1
	10.5	2.0	4.5	1360	51.3	35.0	3.6	63.6	14.3	102.1	6.5	4.3	0.3	0.6	1450	68.5	4.17	54.3	4.8	113.8	65.0	6.0
	10.5	2.0	4.5	1550	52.3	37.5	3.67	64.8	14.3	102.3	6.7	4.5	0.3	0.6	1650	69.5	4.00	55.8	5.1	109.0	65.0	6.1
	14.0	3.5	8.1	1360	52.4	35.5	3.4	64.2	15.2	99.2	6.1	4.3	0.3	0.6	1450	68.5	4.17	54.3	4.8	113.8	65.0	6.0
	14.0	3.5	8.1	1550	53.5	38.0	3.51	65.4	15.2	99.3	6.2	4.5	0.3	0.6	1650	69.5	4.00	55.8	5.1	109.0	65.0	6.1
100	7.0	0.7	1.6	1360	45.5	32.9	4.5	60.7	10.2	117.4	9.7	3.1	0.2	0.4	1450	68.5	4.17	54.3	4.8	113.8	65.0	6.0
	7.0	0.7	1.6	1550	46.4	35.2	4.54	61.9	10.2	117.7	9.9	3.2	0.2	0.4	1650	69.5	4.00	55.8	5.1	109.0	65.0	6.1
	10.5	2.0	4.5	1360	47.7	33.7	4.1	61.7	11.6	111.8	8.6	3.1	0.2	0.4	1450	68.5	4.17	54.3	4.8	113.8	65.0	6.0
	10.5	2.0	4.5	1550	48.6	36.0	4.20	62.9	11.6	112.0	8.8	3.2	0.2	0.4	1650	69.5	4.00	55.8	5.1	109.0	65.0	6.1
	14.0	3.5	8.1	1360	48.8	34.1	4.0	62.3	12.3	108.9	8.1	3.1	0.2	0.4	1450	68.5	4.17	54.3	4.8	113.8	65.0	6.0
	14.0	3.5	8.1	1550	49.7	36.5	4.03	63.5	12.3	109.1	8.2	3.2	0.2	0.4	1650	69.5	4.00	55.8	5.1	109.0	65.0	6.1
110	7.0	0.6	1.4	1360	42.0	31.5	5.1	59.3	8.3	126.9	12.4	2.4	0.1	0.2	1450	68.5	4.17	54.3	4.8	113.8	65.0	6.0
	7.0	0.6	1.4	1550	42.9	33.8	5.15	60.4	8.3	127.3	12.6	2.5	0.1	0.2	1650	69.5	4.00	55.8	5.1	109.0	65.0	6.1
	10.5	1.9	4.4	1360	44.1	32.3	4.7	60.1	9.4	121.4	11.1	2.4	0.1	0.2	1450	68.5	4.17	54.3	4.8	113.8	65.0	6.0
	10.5	1.9	4.4	1550	44.9	34.6	4.78	61.2	9.4	121.7	11.3	2.5	0.1	0.2	1650	69.5	4.00	55.8	5.1	109.0	65.0	6.1
	14.0	3.5	8.0	1360	45.1	32.7	4.5	60.5	10.0	118.6	10.5	2.4	0.1	0.2	1450	68.5	4.17	54.3	4.8	113.8	65.0	6.0
	14.0	3.5	8.0	1550	46.0	35.0	4.61	61.7	10.0	118.8	10.7	2.5	0.1	0.2	1650	69.5	4.00	55.8	5.1	109.0	65.0	6.1
120	7.0	0.4	0.9	1360	38.7	30.3	5.7	58.2	6.8	136.6	15.4	2.0	0.1	0.1	1450	68.5	4.17	54.3	4.8	113.8	65.0	6.0
	7.0	0.4	0.9	1550	39.5	32.5	5.82	59.4	6.8	137.0	15.7	2.0	0.1	0.1	1650	69.5	4.00	55.8	5.1	109.0	65.0	6.1
	10.5	1.7	3.9	1360	40.6	31.0	5.3	58.8	7.6	131.2	14.0	2.0	0.1	0.1	1450	68.5	4.17	54.3	4.8	113.8	65.0	6.0
	10.5	1.7	3.9	1550	41.4	33.2	5.43	59.9	7.6	131.4	14.3	2.0	0.1	0.1	1650	69.5	4.00	55.8	5.1	109.0	65.0	6.1
	14.0	3.3	7.6	1360	41.6	31.3	5.1	59.														

# Performance Data - HZ H/V/D 070 (Full Load), With vFlow®

## 2050 CFM Nominal (Rated) Airflow Heating, 1850 CFM Nominal (Rated) Airflow Cooling

Performance capacities shown in thousands of Btu/h

EWT °F	GPM		WPD		COOLING - EAT 80/67 °F							GPM		WPD		HEATING - 70°F							
			PSI	FT	CFM	TC	SC	kW	HR	EER	LWT			HWC	PSI	FT	CFM	HC	kW	HE	COP	LAT	LWT
20	3.7	0.3	0.6	1630	79.6	49.1	3.5	91.3	22.8	70.0	4.4	17.0	8.9	20.6	1800	46.6	4.66	31.1	2.9	94.0	16.3	4.9	
	3.7	0.3	0.6	1850	81.0	52.8	3.61	93.3	22.4	70.0	4.5	17.0	8.9	20.6	2050	47.3	4.52	31.9	3.1	91.4	16.2	5.0	
30	4.6	0.2	0.5	1630	79.6	49.1	3.5	91.3	22.8	70.0	4.4	8.5	2.2	5.1	1800	51.6	4.77	35.6	3.2	96.5	21.6	5.1	
	4.7	0.3	0.6	1850	81.0	52.8	3.61	93.3	22.4	70.0	4.5	8.5	2.2	5.1	2050	52.4	4.63	36.6	3.3	93.7	21.4	5.2	
	4.6	0.2	0.5	1630	79.6	49.1	3.5	91.3	22.8	70.0	4.4	12.8	4.6	10.6	1800	54.0	4.83	37.8	3.3	97.8	24.1	5.3	
	4.7	0.3	0.6	1850	81.0	52.8	3.61	93.3	22.4	70.0	4.5	12.8	4.6	10.6	2050	54.8	4.68	38.8	3.4	94.8	23.9	5.4	
	4.6	0.3	0.5	1630	79.6	49.1	3.5	91.3	22.8	70.0	4.4	17.0	7.6	17.6	1800	55.3	4.86	39.0	3.3	98.4	25.4	5.3	
	4.7	0.3	0.6	1850	81.0	52.8	3.61	93.3	22.4	70.0	4.5	17.0	7.6	17.6	2050	56.1	4.71	40.1	3.5	95.3	25.3	5.5	
40	6.1	0.5	1.2	1630	79.6	49.1	3.5	91.3	22.8	70.0	4.4	8.5	1.6	3.8	1800	59.4	4.96	42.7	3.5	100.5	29.9	5.6	
	6.2	0.6	1.3	1850	81.0	52.8	3.61	93.3	22.4	70.0	4.5	8.5	1.6	3.8	2050	60.3	4.80	43.9	3.7	97.2	29.7	5.7	
	6.1	0.5	1.2	1630	79.6	49.1	3.5	91.3	22.8	70.0	4.4	12.8	3.9	8.9	1800	62.1	5.02	45.3	3.6	102.0	32.9	5.8	
	6.2	0.6	1.3	1850	81.0	52.8	3.61	93.3	22.4	70.0	4.5	12.8	3.9	8.9	2050	63.1	4.87	46.5	3.8	98.5	32.7	5.9	
	6.1	0.5	1.2	1630	79.6	49.1	3.5	91.3	22.8	70.0	4.4	17.0	6.7	15.5	1800	63.6	5.06	46.6	3.7	102.7	34.5	5.9	
	6.2	0.6	1.3	1850	81.0	52.8	3.61	93.3	22.4	70.0	4.5	17.0	6.7	15.5	2050	64.6	4.90	47.9	3.9	99.2	34.4	6.1	
50	8.5	1.3	3.0	1630	79.1	49.0	3.5	91.0	22.3	71.4	4.5	8.5	1.3	3.0	1800	66.9	5.14	49.6	3.8	104.4	38.3	6.2	
	8.5	1.3	3.0	1850	80.5	52.6	3.67	93.0	21.9	71.9	4.6	8.5	1.3	3.0	2050	67.9	4.99	50.9	4.0	100.7	38.0	6.3	
	9.1	1.6	3.7	1630	79.6	49.1	3.5	91.3	22.8	70.0	4.4	12.8	3.4	7.8	1800	70.1	5.23	52.5	3.9	106.1	41.8	6.5	
	9.3	1.7	3.9	1850	81.0	52.8	3.61	93.3	22.4	70.0	4.5	12.8	3.4	7.8	2050	71.2	5.07	53.9	4.1	102.1	41.5	6.6	
	9.1	1.6	3.7	1630	79.6	49.1	3.5	91.3	22.8	70.0	4.4	17.0	6.0	13.9	1800	71.8	5.27	54.0	4.0	106.9	43.6	6.6	
	9.3	1.7	3.9	1850	81.0	52.8	3.61	93.3	22.4	70.0	4.5	17.0	6.0	13.9	2050	72.9	5.11	55.5	4.2	102.9	43.5	6.8	
60	8.5	1.2	2.7	1630	76.1	47.8	3.9	89.2	19.6	81.0	5.4	8.5	1.2	2.7	1800	74.4	5.34	56.4	4.1	108.3	46.7	6.9	
	8.5	1.2	2.7	1850	77.4	51.4	4.01	91.1	19.3	81.4	5.6	8.5	1.2	2.7	2050	75.5	5.18	57.9	4.3	104.1	46.4	7.1	
	12.8	3.1	7.1	1630	78.3	48.7	3.6	90.6	21.6	74.2	4.7	12.8	3.1	7.1	1800	78.0	5.44	59.6	4.2	110.1	50.7	7.3	
	12.8	3.1	7.1	1850	79.7	52.3	3.76	92.5	21.2	74.5	4.8	12.8	3.1	7.1	2050	79.2	5.28	61.2	4.4	105.8	50.4	7.4	
	17.0	5.6	13.0	1630	79.3	49.1	3.5	91.2	22.6	70.7	4.4	17.0	5.6	13.0	1800	80.0	5.50	61.4	4.3	111.1	52.8	7.5	
	17.0	5.6	13.0	1850	80.7	52.7	3.64	93.1	22.2	71.0	4.5	17.0	5.6	13.0	2050	81.2	5.33	63.0	4.5	106.7	52.6	7.7	
70	8.5	1.1	2.6	1630	72.4	46.3	4.3	86.9	17.0	90.4	6.7	8.5	1.1	2.6	1800	81.9	5.56	63.1	4.3	112.1	55.2	7.7	
	8.5	1.1	2.6	1850	73.7	49.8	4.42	88.7	16.7	90.9	6.8	8.5	1.1	2.6	2050	83.2	5.38	64.8	4.5	107.6	54.8	7.9	
	12.8	3.0	6.8	1630	75.0	47.4	4.0	88.5	18.9	83.8	5.8	12.8	3.0	6.8	1800	86.0	5.68	66.7	4.4	114.2	59.5	8.2	
	12.8	3.0	6.8	1850	76.3	50.9	4.12	90.4	18.5	84.2	5.9	12.8	3.0	6.8	2050	87.3	5.50	68.5	4.6	109.4	59.3	8.4	
	17.0	5.4	12.4	1630	76.3	47.9	3.8	89.3	19.8	80.5	5.4	17.0	5.4	12.4	1800	88.2	5.75	68.7	4.5	115.4	61.9	8.5	
	17.0	5.4	12.4	1850	77.6	51.5	3.99	91.2	19.5	80.7	5.5	17.0	5.4	12.4	2050	89.5	5.57	70.5	4.7	110.4	61.7	8.7	
80	8.5	1.2	2.7	1630	68.4	44.7	4.7	84.4	14.5	99.9	8.2	8.5	1.2	2.7	1800	89.5	5.79	69.9	4.5	116.0	63.6	8.7	
	8.5	1.2	2.7	1850	69.5	48.1	4.89	86.2	14.2	100.3	8.4	8.5	1.2	2.7	2050	90.9	5.61	71.7	4.7	111.0	63.1	8.8	
	12.8	2.9	6.7	1630	71.2	45.8	4.4	86.1	16.2	93.5	7.1	9.5	1.5	3.6	1800	91.2	5.84	71.4	4.6	116.9	65.0	9.0	
	12.8	2.9	6.7	1850	72.4	49.3	4.56	88.0	15.9	93.8	7.3	9.8	1.6	3.8	2050	92.6	5.66	73.3	4.8	111.8	65.0	9.2	
	17.0	5.2	12.1	1630	72.6	46.4	4.2	87.0	17.1	90.2	6.6	9.5	1.5	3.6	1800	91.2	5.84	71.4	4.6	116.9	65.0	9.0	
	17.0	5.2	12.1	1850	73.8	49.9	4.40	88.8	16.8	90.5	6.7	9.8	1.6	3.8	2050	92.6	5.66	73.3	4.8	111.8	65.0	9.2	
90	8.5	1.2	2.8	1630	64.1	43.0	5.3	82.0	12.2	109.3	10.0	5.7	0.2	0.5	1800	91.2	5.84	71.4	4.6	116.9	65.0	9.0	
	8.5	1.2	2.8	1850	65.2	46.2	5.45	83.8	12.0	109.7	10.3	5.9	0.3	0.6	2050	92.6	5.66	73.3	4.8	111.8	65.0	9.2	
	12.8	2.9	6.7	1630	67.0	44.1	4.9	83.6	13.7	103.1	8.8	5.7	0.2	0.5	1800	91.2	5.84	71.4	4.6	116.9	65.0	9.0	
	12.8	2.9	6.7	1850	68.1	47.4	5.07	85.4	13.4	103.4	9.0	5.9	0.3	0.6	2050	92.6	5.66	73.3	4.8	111.8	65.0	9.2	
	17.0	5.2	12.0	1630	68.4	44.7	4.7	84.5	14.5	99.9	8.2	5.7	0.2	0.5	1800	91.2	5.84	71.4	4.6	116.9	65.0	9.0	
	17.0	5.2	12.0	1850	69.6	48.1	4.88	86.3	14.2	100.1	8.4	5.9	0.3	0.6	2050	92.6	5.66	73.3	4.8	111.8	65.0	9.2	
100	8.5	1.2	2.8	1630	59.8	41.2	5.9	79.9	10.2	118.8	12.2	4.1	0.1	0.2	1800	91.2	5.84	71.4	4.6	116.9	65.0	9.0	
	8.5	1.2	2.8	1850	60.9	44.3	6.09	81.6	10.0	119.2	12.5	4.2	0.1	0.2	2050	92.6	5.66	73.3	4.8	111.8	65.0	9.2	
	12.8	2.9	6.7	1630	62.6	42.3	5.5	81.3	11.5	112.7	10.8	4.1	0.1	0.2	1800	91.2	5.84	71.4	4.6	116.9	65.0	9.0	
	12.8	2.9	6.7	1850	63.7	45.5	5.66	83.0	11.2	113.0	11.0	4.2	0.1	0.2	2050	92.6	5.66	73.3	4.8	111.8	65.0	9.2	
	17.0	5.2	12.0	1630	64.0	42.9	5.3	82.0	12.2	109.6	10.1	4.1	0.1	0.2	1800	91.2	5.84	71.4	4.6	116.9	65.0	9.0	
	17.0	5.2	12.0	1850	65.1	46.2	5.46	83.8	11.9	109.9	10.3	4.2	0.1	0.2	2050	92.6	5.66	73.3	4.8	111.8	65.0	9.2	
110	8.5	1.1	2.6	1630	55.7	39.5	6.6	78.3	8.4	128.4	14.7	3.2	0.1	0.1	1800	91.2	5.84	71.4	4.6	116.9	65.0	9.0	
	8.5	1.1	2.6	1850	56.7	42.5	6.85	80.0	8.3	128.8	15.0	3.3	0.1	0.1	2050	92.6	5.66	73.3	4.8	111.8	65.0	9.2	
	12.8	2.9	6.6	1630	58.3	40.6	6.1																



## Part Load Performance Data – Correction Tables

### Air Flow Correction Table

Airflow	Cooling				Heating		
	Total Capacity	Sensible Capacity	Power	Heat of Rejection	Heating Capacity	Power	Heat of Extraction
60%	0.920	0.781	0.959	0.927	0.946	1.241	0.881
69%	0.942	0.832	0.964	0.946	0.960	1.163	0.915
75%	0.956	0.867	0.696	0.959	0.969	1.115	0.937
81%	0.969	0.901	0.975	0.970	0.978	1.076	0.956
88%	0.981	0.934	0.982	0.981	0.986	1.043	0.973
94%	0.991	0.967	0.990	0.991	0.993	1.018	0.988
100%	1.000	1.000	1.000	1.000	1.000	1.000	1.000
106%	1.007	1.033	1.011	1.008	1.006	0.990	1.010
113%	1.013	1.065	1.023	1.015	1.012	0.986	1.017
119%	1.018	1.098	1.036	1.021	1.017	0.983	1.024
125%	1.021	1.131	1.051	1.026	1.021	0.981	1.030
130%	1.023	1.159	1.063	1.030	1.024	0.979	1.034

### Entering Air Correction Tables

Heating			
Entering Air DB°F	Heating Capacity	Power	Heat of Extraction
40	1.084	0.732	1.161
45	1.073	0.764	1.140
50	1.060	0.802	1.117
55	1.046	0.846	1.090
60	1.031	0.893	1.061
65	1.016	0.945	1.031
68	1.006	0.978	1.013
70	1.000	1.000	1.000
75	0.984	1.058	0.968
80	0.968	1.117	0.936

ClimaDry II Option Notes:

Unit minimum entering air temperature when in dehumidification or cooling mode is 65°F DB. Operation below this minimum may result in nuisance faults.

\* = Sensible capacity equals total capacity

AHRI/ISO/ASHRAE 13256-1 uses entering air conditions of Cooling - 80.6°F DB/66.2°F WB, and Heating - 68°F DB/59°F WB entering air temperature

Cooling													
Entering Air WB°F	Total Capacity	Sensible Cooling Capacity Multiplier - Entering DB °F										Power	Heat of Rejection
		60	65	70	75	80	80.6	85	90	95	100		
45	0.876	1.286	1.302	1.389	*	*	*	*	*	*	*	0.981	0.895
50	0.883	1.002	1.099	1.241	*	*	*	*	*	*	*	0.985	0.901
55	0.903	0.706	0.871	1.060	1.271	*	*	*	*	*	*	0.989	0.918
60	0.935		0.617	0.844	1.079	1.319	1.349	*	*	*	*	0.993	0.945
65	0.979			0.595	0.849	1.096	1.128	1.342	*	*	*	0.998	0.982
66.2	0.991			0.531	0.789	1.040	1.070	1.284	1.522	*	*	0.999	0.993
67	1.000			0.486	0.747	1.000	1.030	1.245	1.481	*	*	1.000	1.000
70	1.035				0.583	0.842	0.873	1.090	1.327	1.552	*	1.003	1.030
75	1.105					0.552	0.584	0.811	1.057	1.290	1.510	1.008	1.088

# Full Load Performance Data – Correction Tables

## Air Flow Correction Table

Airflow % of Rated	Cooling				Heating		
	Total Capacity	Sensible Capacity	Power	Heat of Rejection	Heating Capacity	Power	Heat of Extraction
60%	0.925	0.788	0.913	0.922	0.946	1.153	0.896
69%	0.946	0.829	0.926	0.942	0.959	1.107	0.924
75%	0.960	0.861	0.937	0.955	0.969	1.078	0.942
81%	0.972	0.895	0.950	0.968	0.977	1.053	0.959
88%	0.983	0.930	0.965	0.979	0.985	1.032	0.974
94%	0.992	0.965	0.982	0.990	0.993	1.014	0.988
100%	1.000	1.000	1.000	1.000	1.000	1.000	1.000
106%	1.007	1.033	1.020	1.009	1.006	0.989	1.011
113%	1.012	1.064	1.042	1.018	1.012	0.982	1.019
119%	1.016	1.092	1.066	1.025	1.018	0.979	1.027
125%	1.018	1.116	1.091	1.032	1.022	0.977	1.033
130%	1.019	1.132	1.112	1.037	1.026	0.975	1.038

## Entering Air Correction Tables

Heating			
Entering Air DB°F	Heating Capacity	Power	Heat of Extraction
40	1.052	0.779	1.120
45	1.043	0.808	1.102
50	1.035	0.841	1.084
55	1.027	0.877	1.065
60	1.019	0.915	1.045
65	1.010	0.957	1.023
68	1.004	0.982	1.010
70	1.000	1.000	1.000
75	0.989	1.045	0.974
80	0.976	1.093	0.946

### ClimaDry II Option Notes:

Unit minimum entering air temperature when in dehumidification or cooling mode is 65°F DB. Operation below this minimum may result in nuisance faults.

\* = Sensible capacity equals total capacity

AHRI/ISO/ASHRAE 13256-1 uses entering air conditions of Cooling - 80.6°F DB/66.2°F WB, and Heating - 68°F DB/59°F WB entering air temperature

Cooling													
Entering Air WB°F	Total Capacity	Sensible Cooling Capacity Multiplier - Entering DB °F										Power	Heat of Rejection
		60	65	70	75	80	80.6	85	90	95	100		
45	0.832	*	*	*	*	*	*	*	*	*	*	0.946	0.853
50	0.850	1.004	1.174	*	*	*	*	*	*	*	*	0.953	0.870
55	0.880	0.694	0.902	1.115	*	*	*	*	*	*	*	0.964	0.896
60	0.922		0.646	0.875	1.103	1.329	*	*	*	*	*	0.977	0.932
65	0.975			0.639	0.869	1.096	1.123	1.320	*	*	*	0.993	0.979
66.2	0.990			0.582	0.812	1.039	1.066	1.262	*	*	*	0.997	0.991
67	1.000			0.545	0.774	1.000	1.027	1.223	1.444	*	*	1.000	1.000
70	1.040				0.630	0.853	0.880	1.075	1.297	*	*	1.011	1.035
75	1.117					0.601	0.627	0.821	1.046	1.275	1.510	1.033	1.101

# Antifreeze & Water Pressure Drop Adder for Options – Correction Tables

## Antifreeze Correction Table

Antifreeze Type	Antifreeze %	Cooling			Heating		WPD Corr. Fct. EWT 30°F
		EWT 90°F			EWT 30°F		
		Total Cap	Sens Cap	Power	Htg Cap	Power	
Water	0	1.000	1.000	1.000	1.000	1.000	1.000
Propylene Glycol	5	0.995	0.995	1.003	0.989	0.997	1.070
	15	0.986	0.986	1.009	0.968	0.990	1.210
	25	0.978	0.978	1.014	0.947	0.983	1.360
Methanol	5	0.997	0.997	1.002	0.989	0.997	1.070
	15	0.990	0.990	1.007	0.968	0.990	1.160
	25	0.982	0.982	1.012	0.949	0.984	1.220
Ethanol	5	0.998	0.998	1.002	0.981	0.994	1.140
	15	0.994	0.994	1.005	0.944	0.983	1.300
	25	0.986	0.986	1.009	0.917	0.974	1.360
Ethylene Glycol	5	0.998	0.998	1.002	0.993	0.998	1.040
	15	0.994	0.994	1.004	0.980	0.994	1.120
	25	0.988	0.988	1.008	0.966	0.990	1.200

## Modulating Valves for Closed Loop Applications, Low System Pressure Drop

Model	CV	MOPD	WPD Adders		
			GPM	PSI	FT
024	4.7	200	3	0.41	0.94
	4.7	200	4.5	0.92	2.12
	4.7	200	6	1.63	3.76
036	7.4	200	4.5	0.37	0.85
	7.4	200	6.8	0.84	1.95
	7.4	200	9	1.48	3.42
048	10	200	6	0.36	0.83
	10	200	9	0.81	1.87
	10	200	12	1.44	3.33
060	19	200	7.5	0.16	0.36
	19	200	11.3	0.35	0.82
	19	200	15	0.62	1.44
070	19	200	8.5	0.20	0.46
	19	200	12.8	0.45	1.05
	19	200	17	0.80	1.85

## Modulating Valves for Open Loop Applications, High System Pressure Drop

Model	CV	MOPD	WPD Adders		
			GPM	PSI	FT
024	4.7	200	3	0.41	0.94
	4.7	200	4.5	0.92	2.12
	4.7	200	6	1.63	3.76
036	4.7	200	4.5	0.92	2.12
	4.7	200	6.8	2.09	4.84
	4.7	200	9	3.67	8.47
048	4.7	200	6	1.63	3.76
	4.7	200	9	3.67	8.47
	4.7	200	12	6.52	15.06
060	7.4	200	7.5	1.03	2.37
	7.4	200	11.3	2.33	5.39
	7.4	200	15	4.11	9.49
070	7.4	200	8.5	1.32	3.05
	7.4	200	12.8	2.99	6.91
	7.4	200	17	5.28	12.19

## ClimaDry® Additional Pressure Drop (When Operating in Non-ClimaDry Mode)

Model	WPD Adders (Part Load)			WPD Adders (Full Load)		
	GPM	PSI	FT	GPM	PSI	FT
024	3.5	1.200	2.771	4.0	1.567	3.620
	5.8	3.294	7.610	6.0	3.526	8.144
036	4.0	0.689	1.592	4.5	0.872	2.015
	6.0	1.551	3.583	6.8	1.992	4.602
048	5.5	1.303	3.011	6.0	1.551	3.583
	8.3	2.968	6.856	9.0	3.490	8.062
060	7.0	1.299	3.001	7.5	1.491	3.445
	10.5	2.923	6.752	11.3	3.385	7.820
070	7.5	1.491	3.445	8.5	1.915	4.425
	11.3	3.385	7.820	12.8	4.344	10.034

# Variable Pump Performance

## High Head Variable Pump with Check Valve

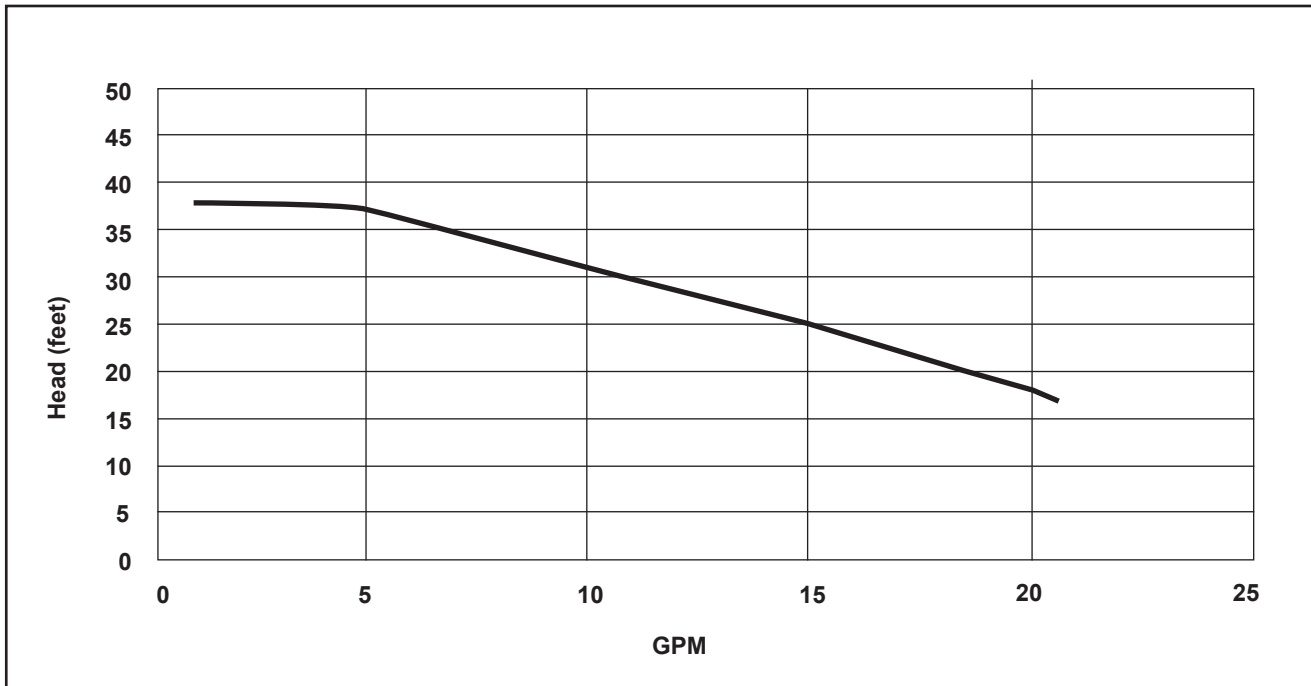

## Standard Head Variable Pump with Check Valve

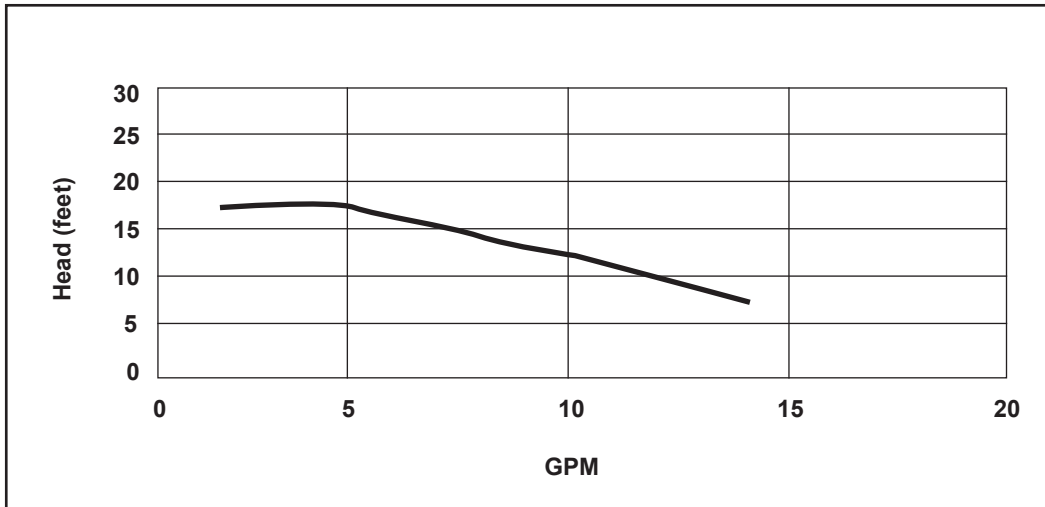

## ECM Blower Control

The ECM fan is controlled directly by the DXM2 control board that converts thermostat inputs and CFM settings to signals used by the ECM motor controller. To take full advantage of the ECM motor features, a communicating multi-stage thermostat should be used (7602-457).

The DXM2 control maintains a selectable operating airflow [CFM] for each heat pump operating mode. For each operating mode there are maximum and minimum airflow limits. See the ECM Blower Performance tables for the maximum, minimum, and default operating airflows.

Airflow levels are selected using the configuration menus of a communicating thermostat (7602-457) or diagnostic tool (7602-444). The configuration menus allow the installer to independently select and adjust the operating airflow for each of the operating modes. Air flow can be selected in 25 CFM increments within the minimum and maximum limits shown in the ECM Blower Performance Table. The blower operating modes include:

- First Stage Cooling (Y1 & O)
- Second Stage Cooling (Y1, Y2, & O)
- First Stage Cooling in Dehumidification Mode (Y1, O, & Dehumid)
- Second Stage Cooling in Dehumidification Mode (Y1, Y2, O, & Dehumid)
- First Stage Heating (Y1)
- Second Stage Heating (Y1 & Y2)
- Third Stage (Auxiliary) Heating (Y1, Y2, & W)
- Emergency Heating (W with no Y1 or Y2)
- Fan (G with no Y1, Y2, or W)

It is highly recommended that 7602-457 or 7602-444 be used to set dehumidification mode electronically. Dehumidification can NOT be selected when using a non-communicating thermostat with a vFlow® unit with Internal Flow Controller (pump). For dehumidification settings on other units using the non-communicating stat, refer to DXM2 AOM (part #97B0003N15).

The ECM motor includes “soft start” and “ramp down” features. The soft start feature is a gentle increase of motor rpm at blower start up. This creates a much quieter blower start cycle.

The ramp down feature allows the blower to slowly decrease rpm to a full stop at the end of each blower cycle. This creates a much quieter end to each blower cycle and adds overall unit efficiency.

The ramp down feature is eliminated during an ESD (Emergency Shut Down) situation. When the DXM2 ESD input is activated, the blower and all other control outputs are immediately de-activated.

The ramp down feature (also known as the heating or cooling “Off Delay”) is field selectable by the installer. The allowable range is 0 to 255 seconds.

### Airflow Configuration Screen on Communicating Thermostat

AIRFLOW SELECTION	
	CFM
HEAT STAGE 1	600
HEAT STAGE 2	750
AUXILIARY HEAT	850
EMERGENCY HEAT	850
COOL STAGE 1	525
COOL STAGE 2	700
COOL DEHUMID 1	425
COOL DEHUMID 2	550
CONTINUOUS FAN	350
HEAT OFF DELAY	60
COOL OFF DELAY	30
◀ PREVIOUS	NEXT ▶

# Blower Performance Data

## Standard Unit (ECM)

Airflow in CFM with wet coil and clean air filter

Model	Max ESP (in wg)	Fan Motor (hp)	Range	Cooling Mode		Dehumid Mode		Heating Mode		Fan Only Mode
				Stg 2	Stg 1	Stg 2	Stg 1	Stg 2	Stg 1	
024	1.0	1/2	Default	700	525	550	425	750	600	350
			Maximum	1000	800	800	600	1000	850	1000
			Minimum	600	450	550	400	600	450	300
036	0.9	1/2	Default	1050	800	850	650	1100	850	550
			Maximum	1500	1100	1200	900	1500	1100	1500
			Minimum	900	600	825	550	900	600	450
048	1.0	1	Default	1400	1050	1100	850	1500	1150	700
			Maximum	2000	1500	1600	1200	2000	1500	2000
			Minimum	1200	900	1100	825	1200	900	600
060	0.7	1	Default	1750	1300	1400	1050	1875	1450	875
			Maximum	2300	1900	2000	1500	2300	1900	2300
			Minimum	1500	1100	1375	1000	1500	1100	750
070	0.7	1	Default	1900	1450	1650	1250	2000	1650	950
			Maximum	2300	2200	2000	1800	2300	2200	2300
			Minimum	1800	1350	1650	1250	1800	1350	900

Airflow is controlled within +/- 5% up to Max ESP shown with wet coil and standard 1" fiberglass filter.  
 ClimaDry II equipped units are factory set to operate in stage 2 airflow.

## HZ Series with ClimaDry II

All HZ units have an ECM fan motor. The small amount of additional pressure drop of the ClimaDry II coil causes the ECM motor to slightly increase RPM to overcome the added pressure drop and maintain selected CFM up to the maximum ESP.

## ClimaDry® II - Benefits and Application

### ClimaDry® II Modulating Reheat

Comfort-Aire/Century's patented ClimaDry® II Dehumidification is an innovative means of providing modulating reheat without the complication of refrigeration controls. ClimaDry® II is hot gas generated reheat, which utilizes one of the biggest advantages of a Water-Source Heat Pump (WSHP), the transfer of energy through the water piping system. ClimaDry® II simply diverts condenser water through a water-to-air coil that is placed after the evaporator coil. If condenser water is not warm enough, the internal "run-around" loop increases the water temperature with each pass through the condenser coil (see figure 1, below).

### ClimaDry® II Benefits

ClimaDry® II is like no other reheat option on the market. Proportional reheat is controlled to the desired leaving air temperature setpoint (factory setpoint of 72°F, 22°C), no matter what the water loop temperature is. Since dehumidification operation will occur under less than full load cooling conditions a good percentage of the time, it is important to have a reheat function that provides 100% reheat in the spring and fall when the water loop is cool. Supply air temperature is field adjustable to +/- 3°F [ +/- 1.7°C] for even greater flexibility with the optional potentiometer. It is recommended that the ClimaDry® supply air temperature be set to match the space cooling setpoint so that ClimaDry® does not impact room temperature. Competitors without ClimaDry® II typically use an on/off (non-modulating) refrigeration based reheat circuit, typically referred to as "Hot gas reheat" (HGR).

HGR needs higher condensing temperatures to work well, typically 85°F [29°C] entering water temperature (EWT). With HGR, cooler water temperatures produce cooler supply air temperatures, which could overcool the space, requiring additional space heating from another source or a special auto-change-over relay to allow the unit to switch back and forth between reheat and heating. Rarely does HGR provide 100% reheat, like ClimaDry® II. ClimaDry® II has a simple and easy to troubleshoot refrigerant circuit. No switching valves or hard to diagnose leaky check valves are utilized. No unusual refrigerant pressures occur during the reheat mode. The ClimaDry® II refrigerant circuit is like every other Comfort-Aire/Century unit (without reheat), so everything the technician already knows applies to troubleshooting the ClimaDry® II refrigeration circuit. Plus, the water loop portion of the ClimaDry® II option is easy to understand and diagnose.

### ClimaDry® II Applications

ClimaDry® II can be applied to a number of common applications, such as:

- Classrooms.
  - Condominiums.
  - Apartments.
  - Computer rooms.
  - Spaces with high latent loads like auditoriums, theaters, convention centers, etc.
  - Most applications where humidity is a problem.
- (Note: ClimaDry® is not for use in high fraction outdoor air applications or in applications with corrosive atmospheres, such as pool rooms.)**

Figure 1: ClimaDry® II Schematic

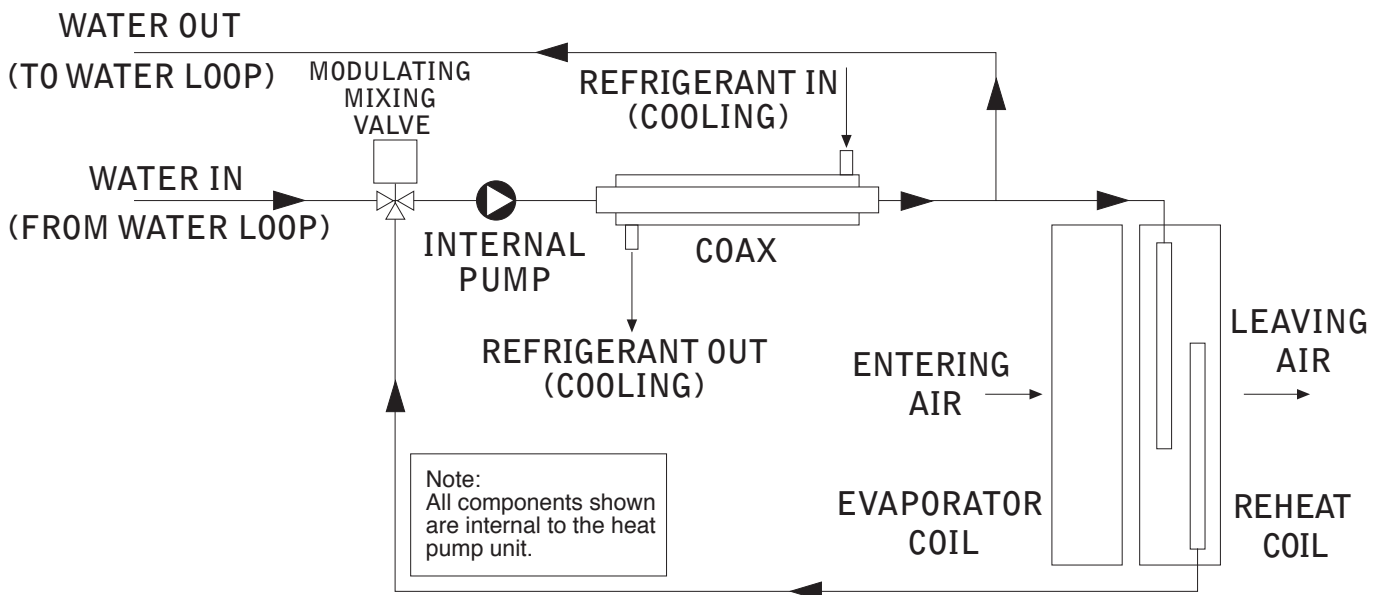

## ClimaDry® II - Benefits and Application

With the ClimaDry® II, return air from the space is cooled by the air-to-refrigerant (evaporator) coil, and then reheated by the water-to-air (reheat) coil to dehumidify the air, but maintain the same space temperature (thus operating as a dehumidifier).

The moisture removal capability of the heat pump is determined by the unit's latent capacity rating. Latent capacity equals Total capacity minus Sensible capacity. Using unit performance data from submittals select the correct model, use your maximum entering water temperature (EWT) and flow rate to select TC and SC. For example, at 80°F [26.7°C] EWT and 6.8 GPM, the moisture removal capability (latent capacity) of a Comfort-Aire/Century unit is 11.8 Mbtuh [3.5kW] as shown below.

Dividing the latent capacity by 1,069 BTU/LB of water vapor at 80°F DB and 67°F WB [26.7°C DB and 19.4°C WB] moist air enthalpy, converts the amount of moisture removal to pounds per hour (multiply pounds per hour by 0.4536 to obtain kg/hr). Calculations are shown below.

Most Comfort-Aire/Century heat pumps have a sensible-to-total (S/T) ratio of 0.72 to 0.82. Therefore, approximately, 25% of the cooling capacity is dedicated to latent cooling capacity (moisture removal). When selecting a unit with ClimaDry® II, the space sensible and latent loads should be calculated. If the unit will be used for space cooling, a unit with at least enough capacity to satisfy the building sensible load should be selected. If the latent cooling load is not satisfied by the selection, a larger unit with enough latent capacity will be required. If the unit will be used for dehumidification purposes only, the latent capacity is the only consideration necessary. In this case, sensible load is immaterial.

**Example Performance**

$LC = TC - SC = 37.2 - 25.4 = 11.8 \text{ Mbtuh}$   
 $11,800 \text{ Btuh} \div 1069 = 11.0 \text{ lbs/hr}$

EWT °F	GPM	WPD		Cooling - EAT 80/67°F							Heating - EAT 70°F					
		PSI	FT	Airflow CFM	TC	SC	Sens/ Total Ratio	kW	HR	EER	Airflow CFM	HC	kW	HE	LAT	COP
70	4.5	1.1	2.5	1080	37.8	25.7	0.68	2.22	45.3	17.0	1080	44.0	2.71	34.8	107.7	4.75
	4.5	1.1	2.5	1250	38.7	28.2	0.73	2.32	46.6	16.7	1250	44.8	2.60	36.0	103.2	5.05
	6.8	2.9	6.7	1080	39.1	26.2	0.67	2.08	46.1	18.8	1080	46.4	2.79	36.9	109.8	4.88
	6.8	2.9	6.7	1250	40.0	28.8	0.72	2.17	47.4	18.4	1250	47.3	2.67	38.2	105.0	5.19
80	4.5	1.0	2.3	1080	35.8	24.8	0.69	2.44	44.2	14.7	1080	48.3	2.84	38.6	111.4	4.98
	4.5	1.0	2.3	1250	36.7	27.2	0.74	2.55	45.4	14.4	1250	49.2	2.73	39.9	106.5	5.29
	6.8	2.8	6.6	1080	37.2	25.4	0.68	2.29	45.0	16.3	1080	51.1	2.93	41.1	113.8	5.10
	6.8	2.8	6.6	1250	38.0	27.9	0.73	2.39	46.2	15.9	1250	52.1	2.81	42.5	108.6	5.43
85	4.5	1.0	2.2	1080	34.8	24.3	0.70	2.57	43.6	13.6	1080	50.5	2.92	40.6	113.3	5.08
	4.5	1.0	2.2	1250	35.6	26.7	0.75	2.68	44.8	13.3	1250	51.5	2.80	41.9	108.1	5.40
	6.8	2.8	6.4	1080	36.2	25.0	0.69	2.40	44.4	15.0	1080	53.5	3.02	43.2	115.9	5.20
	6.8	2.8	6.4	1250	37.0	27.4	0.74	2.51	45.6	14.7	1250	54.5	2.89	44.7	110.4	5.53
90	4.5	0.9	2.1	1080	33.8	23.9	0.71	2.70	43.0	12.5	1080	52.7	2.99	42.5	115.2	5.17
	4.5	0.9	2.1	1250	34.6	26.2	0.76	2.81	44.2	12.3	1250	53.7	2.86	44.0	109.8	5.50
	6.8	2.7	6.2	1080	35.1	24.5	0.70	2.52	43.8	13.9	1080	55.9	3.10	45.3	117.9	5.29
	6.8	2.7	6.2	1250	36.0	26.9	0.75	2.63	45.0	13.7	1250	57.0	2.97	46.9	112.2	5.62

Dividing the latent capacity by 1,069 BTU/LB of water vapor at 80°F DB and 67°F WB [26.7°C DB and 19.4°C WB] moist air enthalpy, converts the amount of moisture removal to pounds per hour (multiply pounds per hour by 0.4536 to obtain kg/hr).



## ClimaDry® II - Sequence of Operation

**ClimaDry® II Sequence of Operation** - A heat pump equipped with ClimaDry® II can operate in three modes; cooling, cooling with reheat (dehumidification), and heating. The cooling/heating modes are like any other Comfort-Aire/Century WSHP. The reversing valve ("O" signal) is energized in cooling, along with the compressor contactor(s) and blower relay. In the heating mode the reversing valve is de-energized. Almost any thermostat will activate the heat pump in heating or cooling modes. The DXM microprocessor board, which is required with the ClimaDry® II option, will accept either heat pump (Y,O) thermostats or non-heat pump (Y,W) thermostats. The reheat mode requires either a separate humidistat/dehumidistat or a thermostat that has an integrated dehumidification function for activation. The DXM board is configured to work with either a humidistat or dehumidistat input to terminal "H". Upon receiving an "H" input, the DXM board will activate the cooling mode and engage reheat. Table 4 shows the relationship between thermostat input signals and unit operation. There are four operational inputs for single stage units and six operational inputs for dual stage units:

- Fan Only
- 1st Stage Cooling
- 2nd Stage Cooling
- 1st Stage Heating
- 2nd Stage Heating
- Reheat Mode

**Fan Only:** A (G) call from the thermostat to the (G) terminal of the DXM control board will bring the unit on in fan only mode. **1st Stage Heating:** A simultaneous call from (G) and (Y1) to the (G) and (Y1) terminals of the DXM control board will bring the unit on in 1st Stage Heating.

**1st Stage Cooling:** A simultaneous call from (G), (Y1), (Y2), and (O) to the (G), (Y1), (Y2), (O/W2) terminals of the DXM control board will bring the unit on in 2nd Stage Cooling. When the call is satisfied at the thermostat, the unit will continue to run in the 1st Stage Cooling until the 1st Stage Cooling call is removed or satisfied, shutting down the unit.

**2nd Stage Cooling:** A simultaneous call from (G), (Y1), and (O) to the (G), (Y1), (O/W2) terminals of the DXM control board will bring the unit on in 1st Stage Cooling.

**Table 2: Humidistat/Dehumidistat Logic and DXM (2.1, 2.2., 2.3) DIP Settings**

Sensor	2.1	2.2	2.3	Logic	Reheat (ON) - H	Reheat (OFF) - H
Humidistat	OFF	OFF	OFF	Reverse	0 VAC	24 VAC
Dehumidistat	OFF	ON	OFF	Standard	24 VAC	0 VAC

**Table 3: ClimaDry® II Operating Modes**

Mode	Input					Output				
	O	G	Y1	Y2 <sup>3</sup>	H	O	G	Y1	Y2 <sup>3</sup>	Reheat
No Demand	ON/OFF	OFF	OFF	OFF	OFF	ON/OFF	OFF	OFF	OFF	OFF
Fan Only	ON/OFF	ON	OFF	OFF	OFF	ON/OFF	ON	OFF	OFF	OFF
Cooling 1st Stage	ON	ON	ON	OFF	OFF	ON	ON	ON	OFF	OFF
Cooling 2nd Stage	ON	ON	ON	ON	OFF	ON	ON	ON	ON	OFF
Cooling & Dehumidistat <sup>1</sup>	ON	ON	ON	ON/OFF	ON	ON	ON	ON	ON/OFF	OFF
Dehumidistat Only	ON/OFF	OFF	OFF	OFF	ON	ON	ON	ON	ON	ON
Heating 1st Stage	OFF	ON	ON	OFF	OFF	OFF	ON	ON	OFF	OFF
Heating 2nd Stage	OFF	ON	ON	ON	OFF	OFF	ON	ON	ON	OFF
Heating & Dehumidistat <sup>2</sup>	OFF	ON	ON	ON/OFF	ON	OFF	ON	ON	ON/OFF	OFF

<sup>1</sup>Cooling input takes priority over dehumidify input.

<sup>2</sup>DXM is programmed to ignore the H demand when the unit is in heating mode.

<sup>3</sup>N/A for single stage units; Full load operation for dual capacity units.

<sup>4</sup>ON/OFF = Either ON or OFF.

## ClimaDry® II - Sequence of Operation

**1st Stage Heating:** A simultaneous call from (G) and (Y1) to the (G) and (Y1) terminals of the DXM control board will bring the unit on in 1st stage Heating.

**2nd Stage Heating:** A simultaneous call from (G), (Y1), and (Y2) to the (G), (Y1), and (Y2) terminals of the DXM control board will bring the unit on in 2nd Stage Heating. When the call is satisfied at the thermostat the unit will continue to run in 1st Stage Heating until the call is removed or satisfied, shutting down the unit. **NOTE: Not all units have two-stage heating functionality.**

**Reheat Mode:** A call from the Humidistat/Dehumidistat to the (H) terminal of the DXM control board will bring the unit on in Reheat Mode if there is no call for cooling at the thermostat. When the Humidistat/Dehumidification call is removed or satisfied the unit will shut down. **NOTE:** Cooling always overrides Reheat Mode. In the Cooling mode, the unit cools and dehumidifies. If the cooling thermostat is satisfied but there is still a call for dehumidification, the unit will continue to operate in Reheat Mode.

**Note: Care must be taken when using a humidistat to operate ClimaDry®. When the DIP switch on the DXM controller is set for 'humidistat' it reverses the control logic so that an "open" control circuit initiates a ClimaDry® run cycle. If a humidistat is not connected, or if a manual switch on the humidistat is set to "off", ClimaDry® will see the open circuit and call for dehumidification.**

### ClimaDry® II Component Functions

The ClimaDry® II option consists of the following components:  
 Motorized Valve/Proportional Controller  
 Supply Air Sensor  
 Loop Pump  
 Hydronic Coil  
 Low Air Temperature Safety

The Proportional Controller operates on 24 VAC power supply and automatically adjusts the water valve based upon the Supply Air Sensor. The Supply Air Sensor senses supply air temperature at the blower inlet providing the input signal necessary for the proportional control to drive the motorized valve during the reheat mode of operation. The Motorized Valve is a proportional actuator/three-way valve combination used to divert the condenser water from the coax to the hydronic reheat coil during the reheat mode of operation. The proportional controller signals the motorized valve based on the supply air temperature of the supply air sensor.

The Loop Pump circulates condenser water through the

hydronic reheat coil during the reheat mode of operation. In this application, the loop pump is only energized during the reheat mode of operation. The Hydronic Coil is utilized during the reheat mode of operation to reheat the air to the setpoint of the proportional controller. Condenser water is diverted by the motorized valve and pumped through the hydronic coil by the loop pump in proportion to the control setpoint. The amount of reheating is dependent on the setpoint and how far from setpoint the supply air temperature is. The factory setpoint is 72°F [22°C], generally considered "neutral" air.

### ClimaDry® II Application Considerations

The reheat coil adds a small amount of resistance to the air stream. Consult the submittal data or the Installation/Operation/Maintenance (I.O.M.) manual for the specific heat pump to review blower tables.

Unlike most hot gas reheat options, the ClimaDry® II option will operate over a wide range of EWTs. Special flow regulation (water regulating valve) is not required for low EWT conditions.

Unit minimum entering air temperature while in the dehumidification, cooling, or continuous fan modes is 65°F DB/55°F WB. Operation below this minimum may result in nuisance faults.

Water-source heat pumps with ClimaDry® II should not be used as make-up air units. These applications should use equipment specifically designed for make-up air.

# Physical Data

Model	024	036	048	060	070
Compressor (1 Each)	Two-Stage Scroll				
Factory Charge (HFC-410A) (oz) [kg]	44 [1.25]	52 [1.47]	69 [1.96]	142 [4.03]	140 [3.97]
<b>ECM Fan Motor &amp; Blower</b>					
Fan Motor (hp) [W]	1/2 [373]	1/2 [373]	1 [746]	1 [746]	1 [746]
Blower Wheel Size (dia x w) - (in) [mm]	9 x 7 [229 x 178]	11 x 10 [279 x 254]	11 x 10 [279 x 254]	11 x 10 [279 x 254]	11 x 10 [279 x 254]
<b>Water Connection Size</b>					
FPT (in)	1	1	1	1	1
<b>HWG Connection Size</b>					
FPT (in)	1/2	1/2	1/2	1/2	1/2
<b>Coax Volume</b>					
Volume (US Gallons) [liters]	0.76 [2.88]	0.92 [3.48]	1.24 [4.69]	1.56 [5.91]	1.56 [5.91]
<b>Vertical Upflow/Downflow</b>					
Air Coil Dimensions (h x w) - (in) [mm]	28 x 20 [711 x 508]	28 x 25 [711 x 635]	32 x 25 [813 x 635]	36 x 25 [914 x 635]	36 x 25 [914 x 635]
Standard Filter - 1" [25.4mm] Throwaway, qty (in) [mm]	28 x 24 [711 x 610]	28 x 29.5 [712 x 749]	32 x 29.5 [813 x 749]	36 x 29.5 [914 x 749]	36 x 29.5 [914 x 749]
Weight - Operating, (lbs) [kg]	298 [135]	359 [163]	448 [203]	475 [215]	475 [215]
Weight - Packaged, (lbs) [kg]	308 [140]	369 [167]	458 [208]	485 [220]	485 [220]
Weight-ClimaDry II (lbs) [kg]	38 [17]	41 [19]	44 [20]	49 [22]	49 [22]
<b>Horizontal</b>					
Air Coil Dimensions (h x w) - (in) [mm]	18 x 31 [457 x 787]	20 x 35 [508 x 889]	20 x 40 [508 x 1016]	20 x 45 [508 x 1143]	20 x 45 [508 x 1143]
Standard Filter - 1" [25.4mm] Throwaway, qty (in) [mm]	2 - 18 x 18 [457 x 457]	1 - 12 x 20 [305 x 508] 1 - 20 x 25 [508 x 635]	1 - 18 x 20 [457 x 508] 1 - 20 x 24 [508 x 610]	2 - 20 x 24 [508 x 610]	2 - 20 x 24 [508 x 610]
Weight - Operating, (lbs) [kg]	298 [135]	359 [163]	448 [203]	475 [215]	475 [215]
Weight - Packaged, (lbs) [kg]	308 [140]	369 [167]	458 [208]	485 [220]	485 [220]
Weight-ClimaDry II (lbs) [kg]	38 [17]	41 [19]	44 [20]	49 [22]	49 [22]

Notes:  
All units have TXV expansion device and 1/2" & 3/4" electrical knockouts.

Unit Maximum Water Working Pressure	
Options	Max Pressure PSIG [kPa]
Base Unit	500 [3447]
Unit with Internal Modulation Water Valve Option	300 [2,068]
Unit with Internal Water Pump Option	145 [999]
Unit with ClimaDry II	145 [999]

## HZ - Horizontal Dimensional Data

Horizontal Model		Overall Cabinet		
		*A Width	B Length	C Height
024	in	22.4	62.2	19.3
	cm	56.8	158.0	48.9
036	in	25.4	71.2	21.3
	cm	64.5	180.8	54.0
048	in	25.4	76.2	21.3
	cm	64.5	193.5	54.0
060 & 070	in	25.4	81.2	21.3
	cm	64.5	206.2	54.0

\*Does not include air filter supports. Add 2" (5.1cm) when a 1" (25.4mm) filter is used, add 3" (7.6cm) when a 2" (50.8mm) filter is used.

Horizontal Model		Water Connections							Water Connections - Units with ClimaDry®	
		1	2	3	4	5	Water Loop FPT	HWG FPT	1	2
		Loop In D	Loop Out E	HWG In F	HWG Out G	Cond. H			Loop In D	Loop Out E
024	in	3.9	8.4	13.9	16.9	3.5	1"	1/2"	2.1	10.0
	cm	9.9	21.3	35.2	42.9	8.9			5.2	25.4
036	in	3.9	8.4	15.6	18.9	3.4	1"	1/2"	6.01	13.1
	cm	9.9	21.3	39.7	47.9	8.6			15.1	33.4
048	in	3.9	8.4	15.6	18.9	3.4	1"	1/2"	6.01	13.1
	cm	9.9	21.3	39.7	47.9	8.6			15.1	33.4
060 & 070	in	3.9	8.4	15.6	18.9	3.4	1"	1/2"	6.01	13.1
	cm	9.9	21.3	39.7	47.9	8.6			15.1	33.4

Horizontal Model		Electrical Knockouts		
		J 1/2"	K 1/2"	L 3/4"
		Low Voltage	External Pump	Power Supply
024	in	3.6	6.1	8.6
	cm	9.2	15.6	21.9
036	in	3.6	6.1	8.6
	cm	9.2	15.6	21.9
048	in	3.6	6.1	8.6
	cm	9.2	15.6	21.9
060 & 070	in	3.6	6.1	8.6
	cm	9.2	15.6	21.9

### Notes:

1. While clear access to all removable panels is not required, installer should take care to comply with all building codes and allow adequate clearance for future field service.
2. Horizontal units shipped with filter bracket only. This bracket should be removed for return duct connection
3. Discharge flange and hanger brackets are factory installed.
4. Condensate is 1" FPT.
5. CCP and BSP requires 2' service access.
6. Blower service access is through back panel on straight discharge units or through panel opposite air coil on back discharge units.

### Legend:

CCP = Control/Compressor Access Panel  
 BSP = Blower Service Panel  
 ASP = (Optional) Additional Service Panel

# HZ - Horizontal Dimensional Data

Horizontal Model		Discharge Connection Duct Flange Installed						Return Connection Using Return Air Opening				Return Connection Using Optional Air Filter Frame			
		M	N	O Supply Height	P Supply Width	Q	R	S Return Width	T Return Height	U	V	S Return Width	T Return Height	U	V
024	in	3.6	2.0	15.5	12.5	3.6	2.0	32.1	17.3	2.3	1.0	33.8	16.2	2.3	1.7
	cm	9.3	5.1	39.4	31.8	9.2	5.2	81.5	43.9	5.8	2.5	85.8	41.0	5.8	4.3
036	in	3.1	1.2	19.0	17.5	3.1	1.0	36.1	19.3	2.3	1.0	34.8	18.2	3.1	1.7
	cm	7.9	3.1	48.3	44.5	7.9	2.6	91.7	49.0	5.7	2.5	88.3	46.1	7.8	4.3
048	in	3.1	1.2	19.0	17.5	3.1	1.0	41.1	19.3	2.3	1.0	39.8	18.2	3.1	1.7
	cm	7.9	3.1	48.3	44.5	7.9	2.6	104.4	49.0	5.7	2.5	101.0	46.1	7.8	4.3
060 & 070	in	3.1	1.2	19.0	17.5	3.1	1.0	46.1	19.3	2.3	1.0	44.8	18.2	3.1	1.7
	cm	7.9	3.1	48.3	44.5	7.9	2.6	117.1	49.0	5.7	2.5	113.7	46.1	7.8	4.3

All dimensions are +/- 0.20 in. (+/-5.1 mm).

\*ASP are removable panels that provide additional access to the units interior. Clear access to ASP panels is not required and they are not to be used in place of the mandatory CCP and BSP panels.

### LEFT RETURN

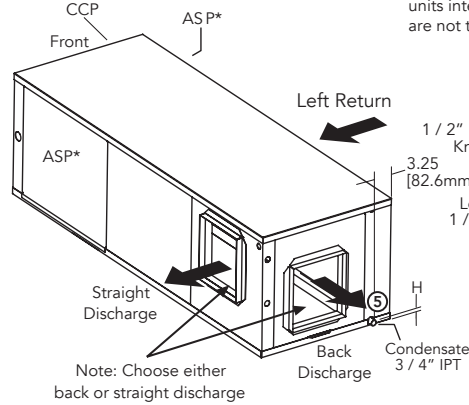

### RIGHT RETURN

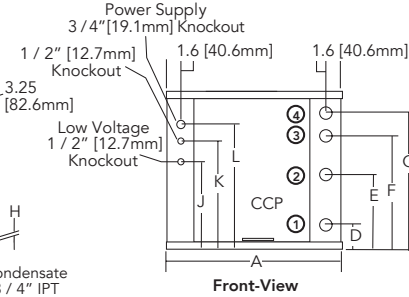
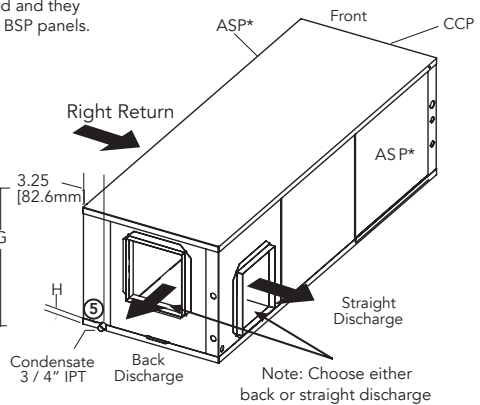

### Unit Hanger Detail

Model	X		Y		Z	
	in.	cm.	in.	cm.	in.	cm.
024	62.1	157.7	24.5	62.2	20.25	51.5
036	71.1	180.6	27.5	69.9	23.25	59.1
048	76.1	193.3	27.5	69.9	23.25	59.1
060	81.1	206.0	27.5	69.9	23.25	59.1
070	81.1	206.0	27.5	69.9	23.25	59.1

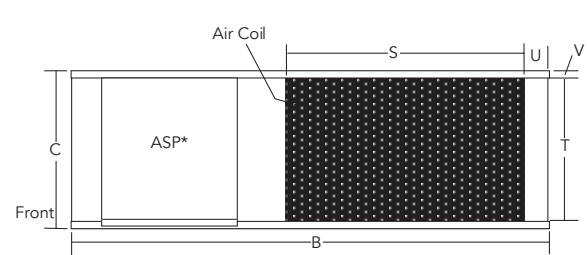
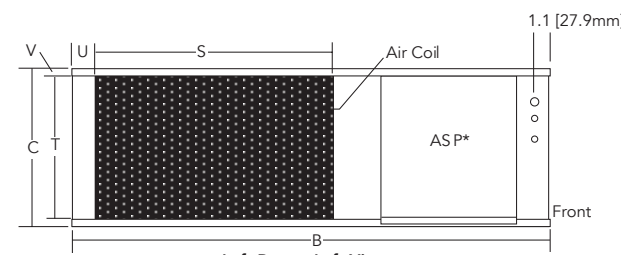
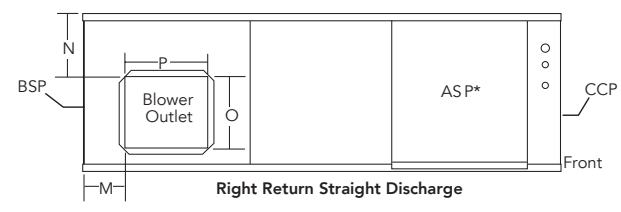
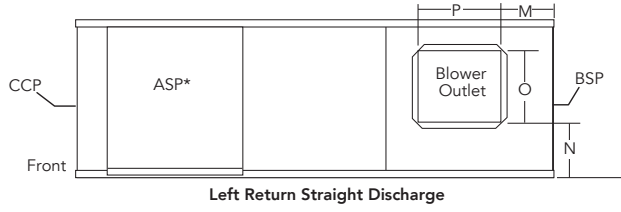
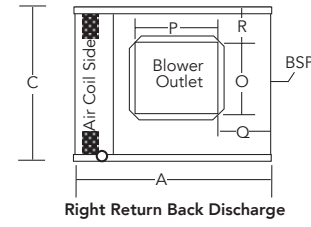
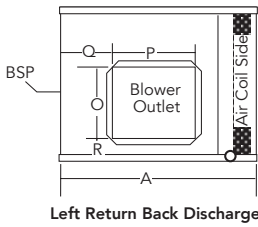

Filter Rails Removed  
See Aff ---- for accessory air filter frame with duct collar

# HZ - Horizontal Service Access

### Left Return Back Discharge

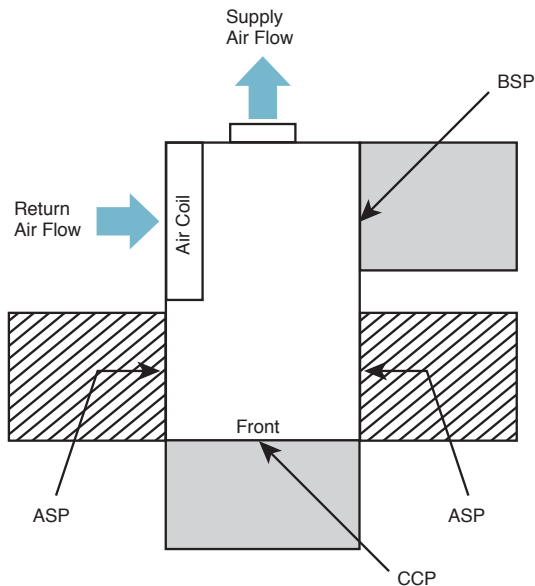

### Right Return Back Discharge

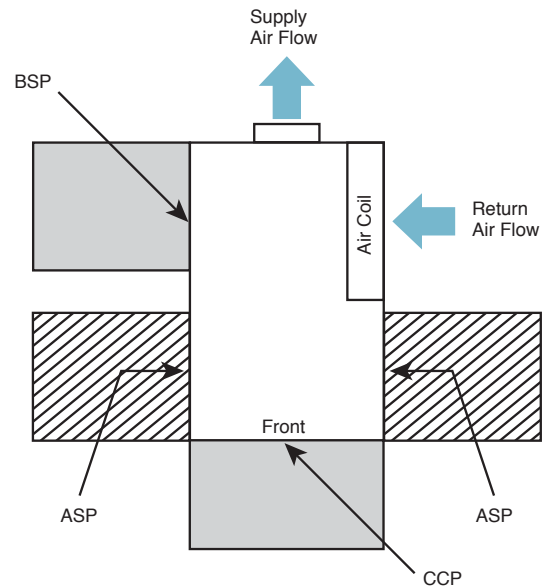

### Left Return Straight Discharge

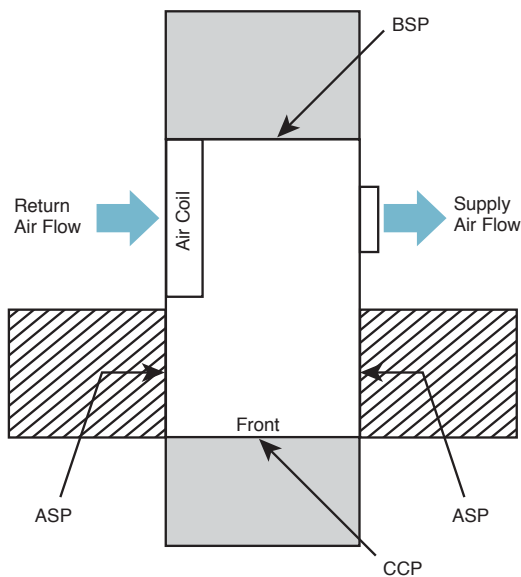

### Right Return Straight Discharge

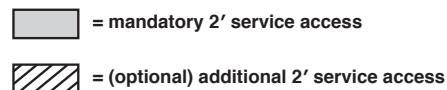
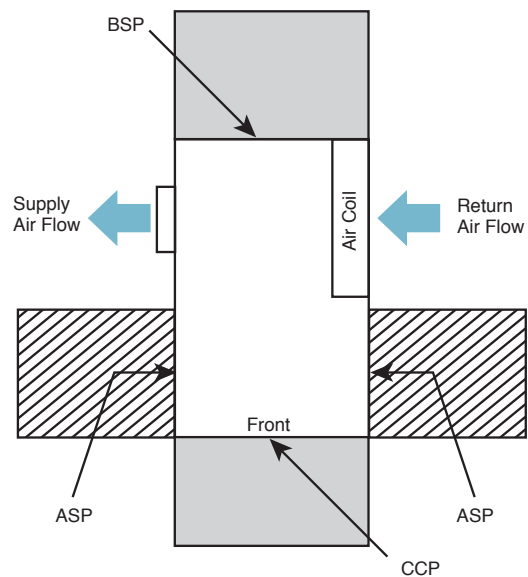

## Notes:

1. While clear access to all removable panels is not required, installer should take care to comply with all building codes and allow adequate clearance for future field service.
2. CCP and BSP requires 2' service access.
3. Blower service access is through back panel on straight discharge units or through panel opposite air coil on back discharge units.
4. ASP are removable panels that provide additional access to the units interior. Clear access to ASP panels is not required and they are not to be used in place of the mandatory CCP and BSP panels.

## Legend:

CCP = Control/Compressor Access Panel  
 BSP = Blower Service Panel  
 ASP = (Optional) Additional Service Panel

## HZ - Vertical Upflow Dimensional Data

Vertical Upflow Model		Overall Cabinet		
		*A Width	B Depth	C Height
024	in	22.4	25.6	48.5
	cm	56.8	65.1	123.2
036	in	25.4	30.6	50.5
	cm	64.5	77.8	128.3
048	in	25.4	30.6	54.5
	cm	64.5	77.8	138.4
060 & 070	in	25.4	30.6	58.5
	cm	64.5	77.8	148.6

\*Does not include air filter supports. Add 2" (5.1cm) when a 1" (25.4mm) filter is used, add 3" (7.6cm) when a 2" (50.8mm) filter is used.

Vertical Upflow Model		Electrical Knockouts		
		J 1/2"	K 1/2"	L 3/4"
		Low Voltage	External Pump	Power Supply
024	in	3.6	6.1	8.6
	cm	9.2	15.6	21.9
036	in	3.6	6.1	8.6
	cm	9.2	15.6	21.9
048	in	3.6	6.1	8.6
	cm	9.2	15.6	21.9
060 & 070	in	3.6	6.1	8.6
	cm	9.2	15.6	21.9

Vertical Upflow Model		Water Connections							Water Connections - Units with ClimaDry®	
		1	2	3	4	5	Water Loop FPT	HWG FPT	1	2
		Loop In D	Loop Out E	HWG In F	HWG Out G	Cond. H			Loop In D	Loop Out E
024	in	3.9	8.4	13.9	16.9	6.3	1"	1/2"	2.1	10.0
	cm	9.9	21.3	35.2	42.9	16.0			5.2	25.4
036	in	3.9	8.4	15.6	18.9	6.3	1"	1/2"	6.0	13.1
	cm	9.9	21.3	39.7	47.9	16.0			15.1	33.4
048	in	3.9	8.4	15.6	18.9	6.3	1"	1/2"	6.0	13.1
	cm	9.9	21.3	39.7	47.9	16.0			15.1	33.4
060 & 070	in	3.9	8.4	15.6	18.9	6.3	1"	1/2"	6.0	13.1
	cm	9.9	21.3	39.7	47.9	16.0			15.1	33.4

### Notes:

1. While clear access to all removable panels is not required, installer should take care to comply with all building codes and allow adequate clearance for future field service.
2. Front & Side access is preferred for service access. However, all components may be serviced from the front access panel if side access is not available.
3. Discharge flange is field installed.
4. Condensate is 1" FPT PVC and is switchable from front to side.

### Legend:

CCP = Control/Compressor Access Panel  
 BSP = Blower Service Panel  
 ASP = (optional) Additional Service Panel

Recommended Minimum Installation Clearances for Vertical Units*	
1"	Back of unit
	Side opposite return air
6"	Front if hard piped
Return Air Side	
1"	Ducted return
	- ± *Add for duct width
	- † Add 2" for 1" filter frame/rail or 3" for 2" filter frame/rail
	Free (open) return - calculate required dimension for a maximum velocity of 600 fpm

\*Field installed accessories (hoses, air cleaners, etc.) and factory WSE option will require additional space. Top supply air is shown, the same clearances apply to bottom supply air units.

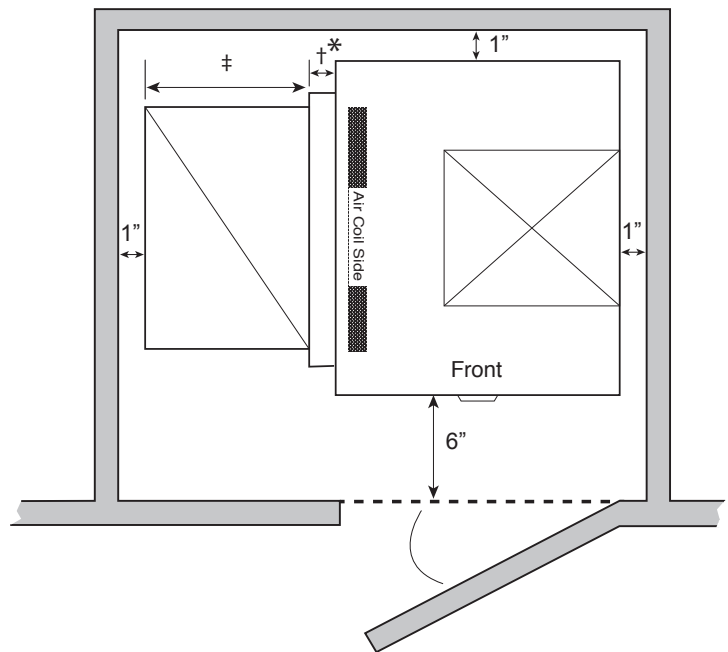

# HZ - Vertical Upflow Dimensional Data

Vertical Upflow Model	Discharge Connection Duct Flange Installed						Return Connection Using Return Air Opening				Return Connection Using Optional Air Filter Frame			
	M	N	O Supply Width	P Supply Depth	Q	R	S Return Depth	T Return Height	U	R	S Return Depth	T Return Height	U	
<b>024</b>	in cm	7.2 18.3	5.8 14.8	14.0 35.6	14.0 35.6	4.9 12.4	2.3 5.8	21.1 53.6	27.7 70.4	1.0 2.5	1.7 4.3	22.2 56.4	26.2 66.5	1.7 4.3
<b>036</b>	in cm	6.4 16.1	6.3 16.0	18.0 45.7	18.0 45.7	5.3 13.5	2.3 5.8	26.1 66.3	27.7 70.4	1.0 2.5	1.7 4.3	27.2 69.1	26.2 66.5	1.7 4.3
<b>048</b>	in cm	6.4 16.1	6.3 16.0	18.0 45.7	18.0 45.7	5.3 13.5	2.3 5.8	26.1 66.3	31.7 80.5	1.0 2.5	1.7 4.3	27.2 69.1	30.2 76.7	1.7 4.3
<b>060 &amp; 070</b>	in cm	6.4 16.1	6.3 16.0	18.0 45.7	18.0 45.7	5.3 13.5	2.3 5.8	26.1 66.3	35.7 90.7	1.0 2.5	1.7 4.3	27.2 69.1	34.2 86.9	1.7 4.3

All dimensions are +/- 0.20 in, (+/-5.1 mm).

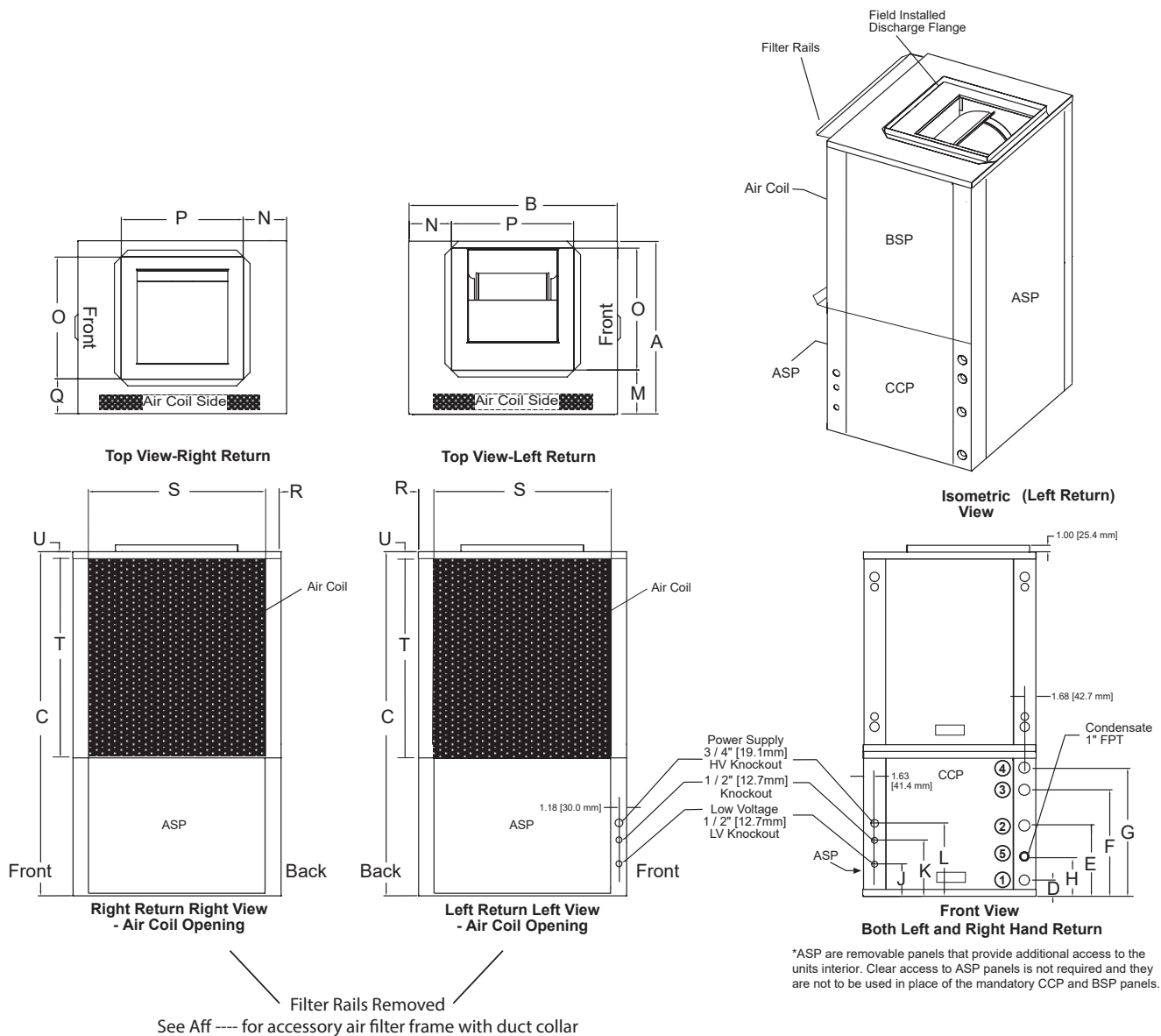



# HZ - Vertical Service Access

## Vertical Units

### Left Return

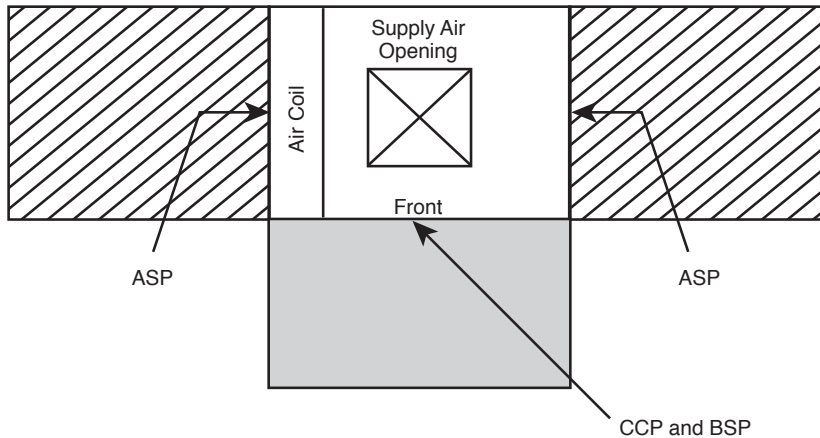

### Right Return

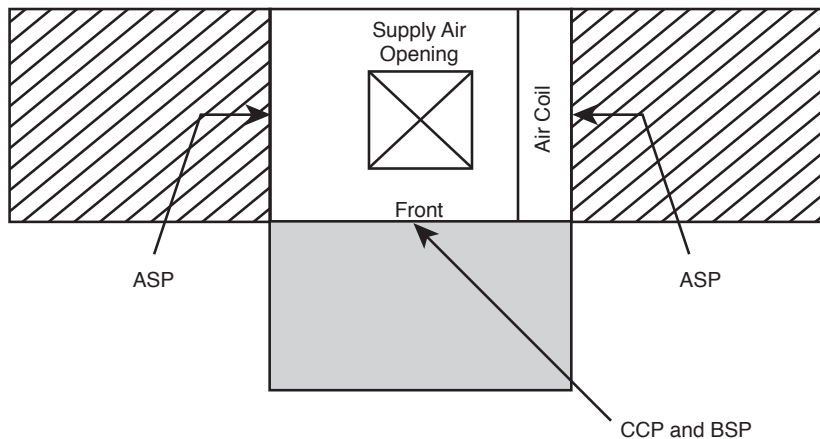

- = mandatory 2' service access
- = (optional) additional 2' service access

### Notes:

1. While clear access to all removable panels is not required, installer should take care to comply with all building codes and allow adequate clearance for future field service.
2. Front & Side access is preferred for service access. However, all components may be serviced from the front access panel if side access is not available.
3. ASP are removable panels that provide additional access to the units interior. Clear access to ASP panels is not required and they are not to be used in place of the mandatory CCP and BSP panels.
4. Top supply air is shown, the same clearances apply to bottom supply air units.

### Legend:

- CCP = Control/Compressor Access Panel
- BSP = Blower Service Panel
- ASP = (optional) Additional Service Panel

# HZ - Vertical Downflow Dimensional Data

Vertical Downflow Model		Overall Cabinet		
		*A Width	B Depth	C Height
024	in	22.4	25.6	52.5
	cm	56.8	65.1	133.4
036	in	25.4	30.6	54.5
	cm	64.5	77.8	138.4
048	in	25.4	30.6	58.5
	cm	64.5	77.8	148.6
060 & 070	in	25.4	30.6	62.5
	cm	64.5	77.8	158.8

Vertical Downflow Model		Electrical Knockouts		
		J 1/2"	K 1/2"	L 3/4"
		Low Voltage	External Pump	Power Supply
024	in	3.6	6.1	8.6
	cm	9.2	15.6	21.9
036	in	3.6	6.1	8.6
	cm	9.2	15.6	21.9
048	in	3.6	6.1	8.6
	cm	9.2	15.6	21.9
060 & 070	in	3.6	6.1	8.6
	cm	9.2	15.6	21.9

\*Does not include air filter supports. Add 2" (5.1cm) when a 1" (25.4mm) filter is used, add 3" (7.6cm) when a 2" (50.8mm) filter is used.

Vertical Downflow Model		Water Connections						
		1	2	3	4	5	Water Loop FPT	HWG FPT
		Loop In D	Loop Out E	HWG In F	HWG Out G	Cond. H		
024	in	15.4	10.9	5.4	2.4	4.7	1"	1/2"
	cm	39.1	27.7	13.7	6.1	11.9		
036	in	17.4	12.9	5.7	2.4	4.7	1"	1/2"
	cm	44.2	32.8	14.5	6.1	11.9		
048	in	17.4	12.9	5.7	2.4	4.7	1"	1/2"
	cm	44.2	32.8	14.5	6.1	11.9		
060 & 070	in	17.4	12.9	5.7	2.4	4.7	1"	1/2"
	cm	44.2	32.8	14.5	6.1	11.9		

Recommended Minimum Installation Clearances for Vertical Units*	
1"	Back of unit
	Side opposite return air
6"	Front if hard piped
Return Air Side	
1"	Ducted return
	- ‡ *Add for duct width - † Add 2" for 1" filter frame/rail or 3" for 2" filter frame/rail
	Free (open) return - calculate required dimension for a maximum velocity of 600 fpm

\*Field installed accessories (hoses, air cleaners, etc.) and factory WSE option will require additional space. Top supply air is shown, the same clearances apply to bottom supply air units.

### Notes:

- While clear access to all removable panels is not required, installer should take care to comply with all building codes and allow adequate clearance for future field service.
- Front & Side access is preferred for service access. However, all components may be serviced from the front access panel of a standard unit if side access is not available.
- Condensate is 1" FPT PVC and is switchable from front to side.
- Top supply air is shown, the same clearances apply to bottom supply air units.

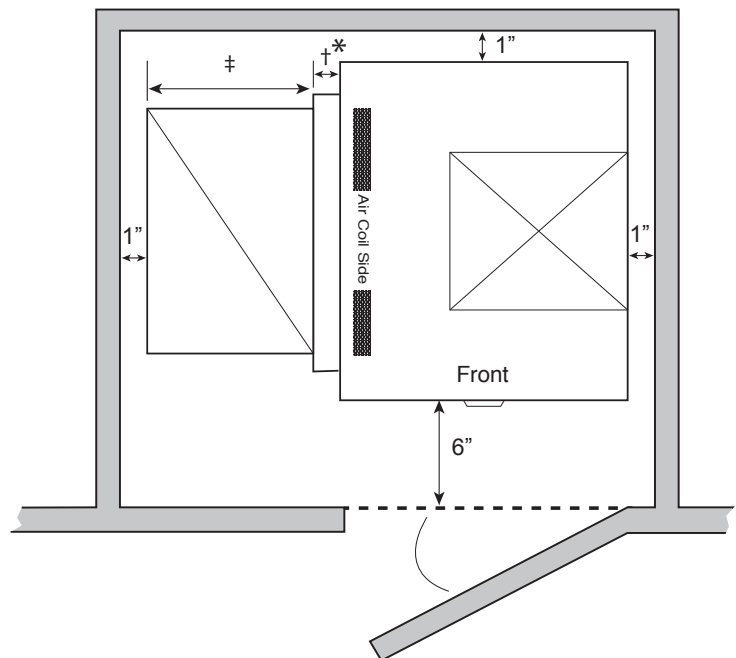

### Legend:

- CCP = Control/Compressor Access Panel
- BSP = Blower Service Panel
- ASP = (optional) Additional Service Panel

# HZ - Vertical Downflow Dimensional Data

Vertical Downflow Model		Discharge Connection Duct Flange Installed					Return Connection Using Return Air Opening				Return Connection Using Optional Air Filter Frame			
		M	N	O Supply Width	P Supply Depth	Q	R	S Return Depth	T Return Height	U	R	S Return Depth	T Return Height	U
024	in	6.7	8.4	10.1	9.1	10.8	2.2	21.1	27.7	21.2	1.7	22.2	26.2	21.9
	cm	17.1	21.4	25.7	23.0	27.4	5.6	53.6	70.4	53.8	4.3	56.4	66.5	55.6
036	in	7.2	9.0	13.4	12.9	10.4	2.2	26.1	27.7	23.2	1.7	27.2	26.2	23.9
	cm	18.3	22.9	34.0	32.7	26.5	5.6	66.3	70.4	58.9	4.3	69.1	66.5	60.7
048	in	7.2	9.0	13.4	12.9	10.4	2.2	26.1	31.7	23.2	1.7	27.2	30.2	23.9
	cm	18.3	22.9	34.0	32.7	26.5	5.6	66.3	80.5	58.9	4.3	69.1	76.7	60.7
060 & 070	in	7.2	9.0	13.4	12.9	10.4	2.2	26.1	35.7	23.2	1.7	27.2	34.2	23.9
	cm	18.3	22.9	34.0	32.7	26.5	5.6	66.3	90.7	58.9	4.3	69.1	86.9	60.7

All dimensions are +/- 0.20 in, (+/-5.1 mm).

**Legend:**

- CCP = Control/Compressor Access Panel
- BSP = Blower Service Panel
- ASP = Additional Service Panel (not required)

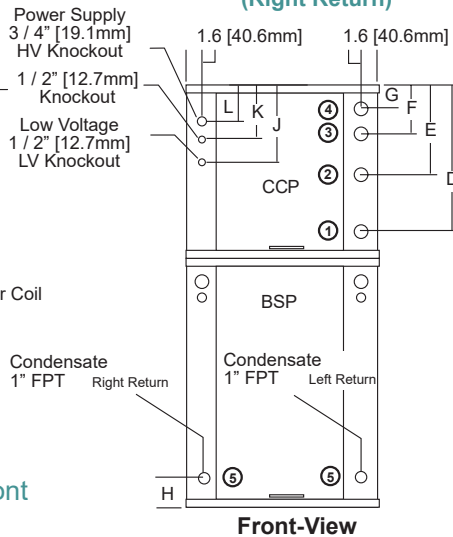
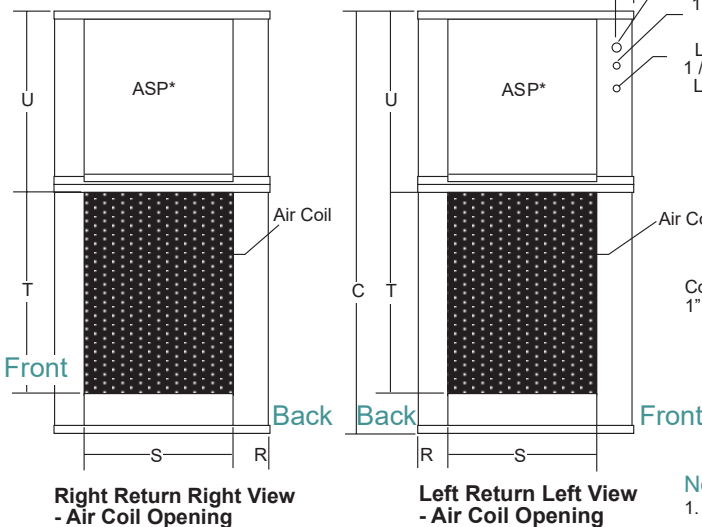
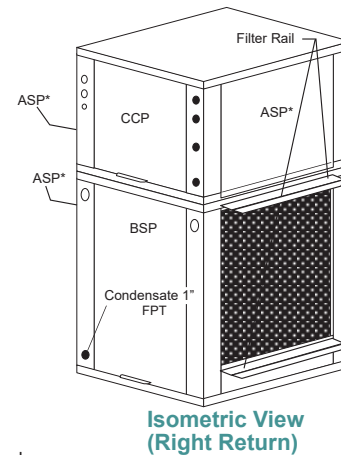
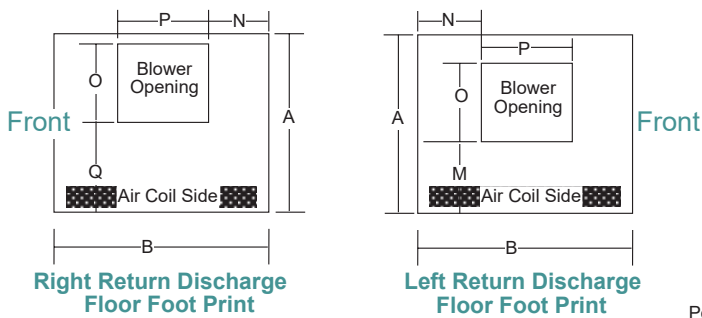

**Notes:**

1. While clear access to all removable panels is not required, installer should take care to comply with all building codes and allow adequate clearance for future field service.
2. Front & Side access is preferred for service access. However, all components may be serviced from the front access panel if side access is not available.
3. Condensate is 1" FPT PVC.
4. ASP are removable panels that provide additional access to the units interior. Clear access to ASP panels is not required and they are not to be used in place of the mandatory CCP and BSP panels.

Filter Rails Removed  
See Aff ---- for accessory air filter frame with duct collar

# Corner Weights

## Corner Weights for HZ Series Horizontal Units

Model		Total	Left-Front*	Right-Front*	Left-Back**	Right-Back**
024	Lbs	298	88	75	78	57
	kg	135	40	34	35	26
036	Lbs	359	115	82	92	70
	kg	163	52	37	42	32
048	Lbs	448	156	100	106	86
	kg	203	71	45	48	39
060	Lbs	475	196	78	85	116
	kg	215	89	35	39	53
070	Lbs	475	196	78	85	116
	kg	215	89	35	39	53

\*Front is control box end.

+ Weights shown are for units with left hand return air. Reverse these for a right hand return air unit.

# Electrical Data

## Standard Units

Model	Voltage Code	Voltage	Min/Max Voltage	Compressor			Fan Motor FLA	Total Unit FLA	Min Circ Amp	Max Fuse/HACR
				RLA	LRA	Qty				
024	1	208/230/60/1	197/252	11.7	58.3	1	3.9	15.6	18.5	30
036	1	208/230/60/1	197/252	15.3	83.0	1	3.9	19.2	23.0	35
048	1	208/230/60/1	197/252	21.2	104.0	1	6.9	28.1	33.4	50
060	1	208/230/60/1	197/252	27.1	152.9	1	6.9	34.0	40.8	60
070	1	208/230/60/1	197/252	29.7	179.2	1	6.9	36.6	44.0	70

Wire length based on one way measurement with 2% voltage drop  
 Wire size based on 60°C copper conductor  
 All fuses Class RK-5

**\* NEUTRAL CONNECTION REQUIRED!** All F Voltage (460 vac) units with ECM motors require a four wire power supply with neutral. ECM motor is rated 265 vac and is wired between one hot leg and neutral.

## Units with Secondary Pump or ClimaDry II

Model	Voltage Code	Voltage	Min/Max Voltage	Compressor			Internal Pump FLA	Fan Motor FLA	Total Unit FLA	Min Circ Amp	Max Fuse/HACR
				RLA	LRA	Qty					
024	1	208/230/60/1	197/252	11.7	58.3	1	0.8	3.9	16.4	19.3	30
036	1	208/230/60/1	197/252	15.3	83.0	1	0.8	3.9	20.0	23.8	35
048	1	208/230/60/1	197/252	21.2	104.0	1	0.8	6.9	28.9	34.2	50
060	1	208/230/60/1	197/252	27.1	152.9	1	1.1	6.9	35.1	41.8	60
070	1	208/230/60/1	197/252	29.7	179.2	1	1.1	6.9	37.7	45.1	70

Wire length based on one way measurement with 2% voltage drop  
 Wire size based on 60°C copper conductor  
 All fuses Class RK-5

**\* NEUTRAL CONNECTION REQUIRED!** All F Voltage (460 vac) units with ECM motors/internal secondary circulators require a four wire power supply with neutral. ECM motors/ClimaDry pump/internal secondary circulators are rated 265 vac and are wired between one hot leg and neutral.

# Electrical Data

## Units with Variable Pump High Head

Model	Voltage Code	Voltage	Min/Max Voltage	Compressor			Pump FLA	Fan Motor FLA	Total Unit FLA	Min Circ Amp	Max Fuse/HACR
				RLA	LRA	Qty					
024	1	208/230/60/1	197/252	11.7	58.3	1	1.44	3.9	17.0	20.0	30
036	1	208/230/60/1	197/252	15.3	83.0	1	1.44	3.9	20.6	24.5	40
048	1	208/230/60/1	197/252	21.2	104.0	1	1.44	6.9	29.5	34.8	50
060	1	208/230/60/1	197/252	27.1	152.9	1	1.44	6.9	35.4	42.2	60
070	1	208/230/60/1	197/252	29.7	179.2	1	1.44	6.9	38.0	45.5	70

Wire length based on one way measurement with 2% voltage drop  
 Wire size based on 60°C copper conductor  
 All fuses Class RK-5

\* NEUTRAL CONNECTION REQUIRED! All F Voltage (460 vac) units with ECM motors/internal pumps require a four wire power supply with neutral. ECM motors/internal pumps are rated 265 vac and are wired between one hot leg and neutral.

## Units with Variable Pump Standard Head

Model	Voltage Code	Voltage	Min/Max Voltage	Compressor			Pump FLA	Fan Motor FLA	Total Unit FLA	Min Circ Amp	Max Fuse/HACR
				RLA	LRA	Qty					
024	1	208/230/60/1	197/252	11.7	58.3	1	0.7	3.9	16.3	19.2	30
036	1	208/230/60/1	197/252	15.3	83.0	1	0.7	3.9	19.9	23.7	35
048	1	208/230/60/1	197/252	21.2	104.0	1	0.7	6.9	28.8	34.1	50
060	1	208/230/60/1	197/252	27.1	152.9	1	0.7	6.9	34.7	41.5	60
070	1	208/230/60/1	197/252	29.7	179.2	1	0.7	6.9	37.3	44.7	70

Wire length based on one way measurement with 2% voltage drop  
 Wire size based on 60°C copper conductor  
 All fuses Class RK-5

\* NEUTRAL CONNECTION REQUIRED! All F Voltage (460 vac) units with ECM motors/internal pumps require a four wire power supply with neutral. ECM motors/internal pumps are rated 265 vac and are wired between one hot leg and neutral.

## HZ Series Wiring Diagram Matrix

Voltage	Description	Diagram Part Number
208-230/60/1	W/ MOD VALVE	96B0242N01
	W/ LON / MOD VALVE	96B0242N02
	W/ MPC / MOD VALVE	96B0242N03
	W/ ISP / NO PUMP OR VALVE OPTION	96B0242N05
	W/ LON / ISP / NO PUMP OR VALVE OPTION	96B0242N06
	W/ MPC / ISP / NO PUMP OR VALVE OPTION	96B0242N07
	W/ VARIABLE PUMP – 265 VOLTAGE	96B0242N09
	W/ VARIABLE PUMP – 208-230 VOLTAGE	96B0242N12
	W/ CLIMADRY	96B0242N08
	W/ CLIMADRY/ MPC	96B0242N21
	W/ CLIMADRY/ Lon	96B0242N20

# Typical Wiring Diagram - Single Phase HZ Units with Modulating Water Valve

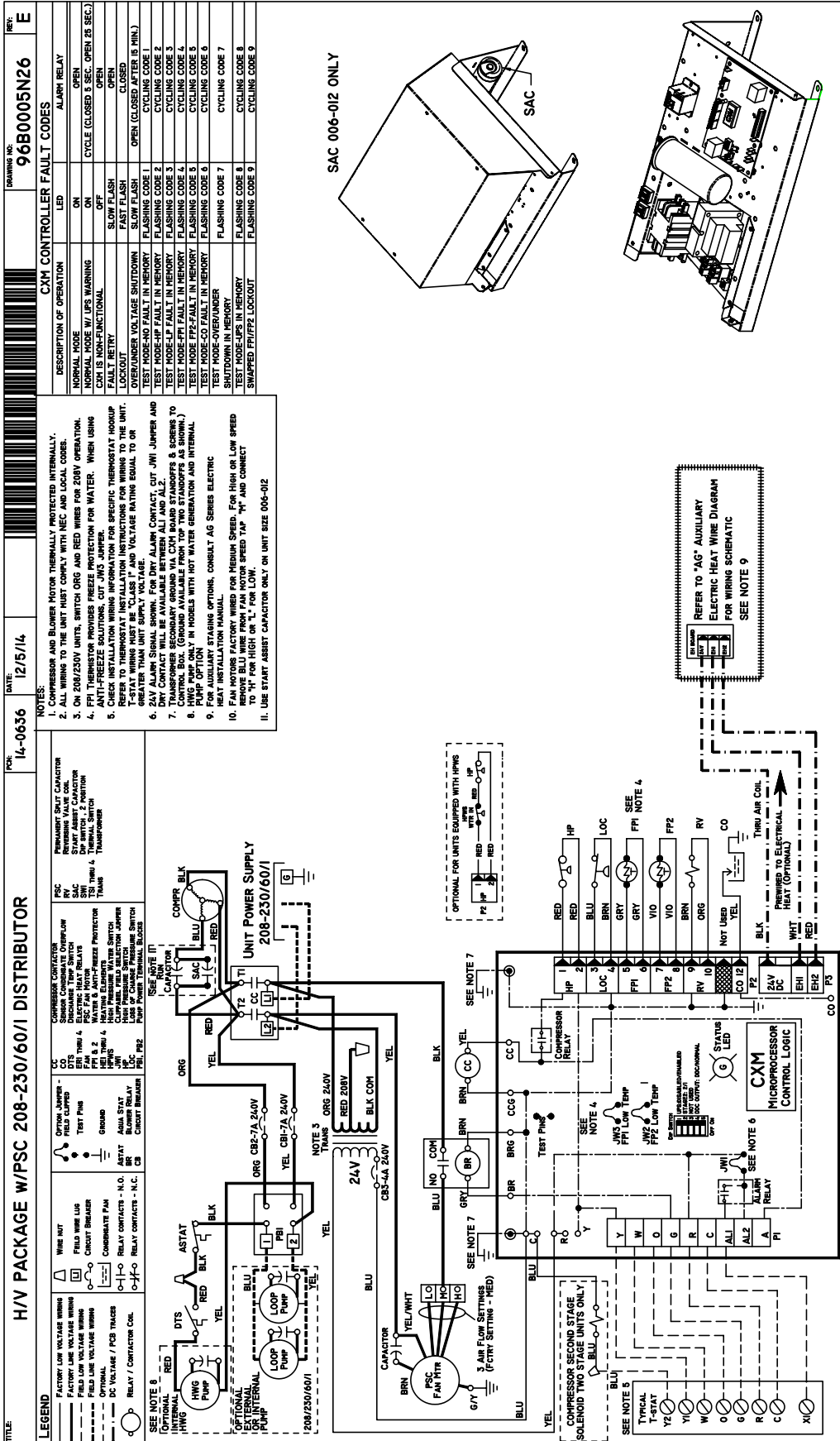



# Typical Wiring Diagram - Single Phase 208/230V HZ Units with Variable Pump

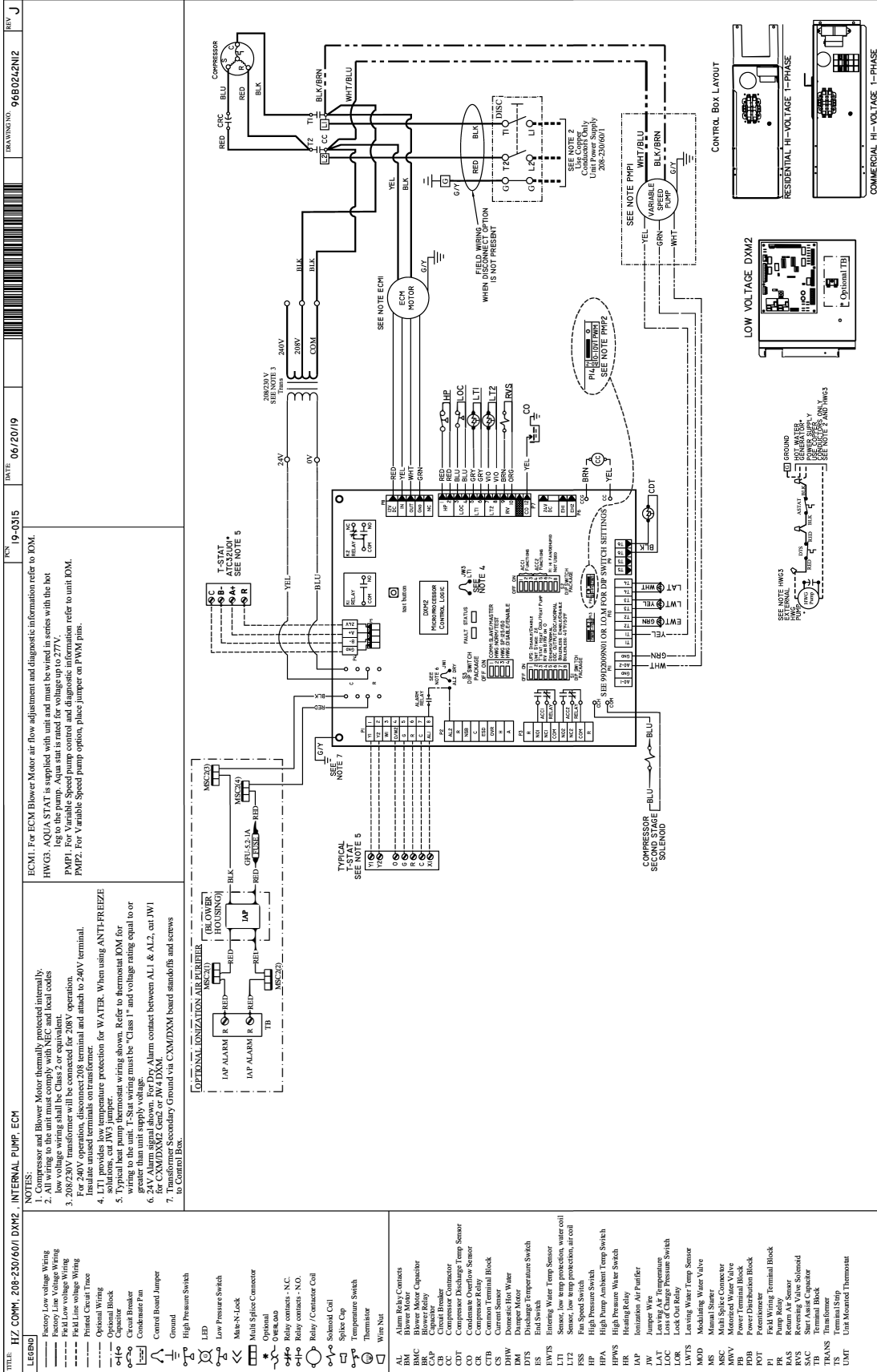



# Typical Wiring Diagram - Single Phase HZ Units with MWV and LON Controller

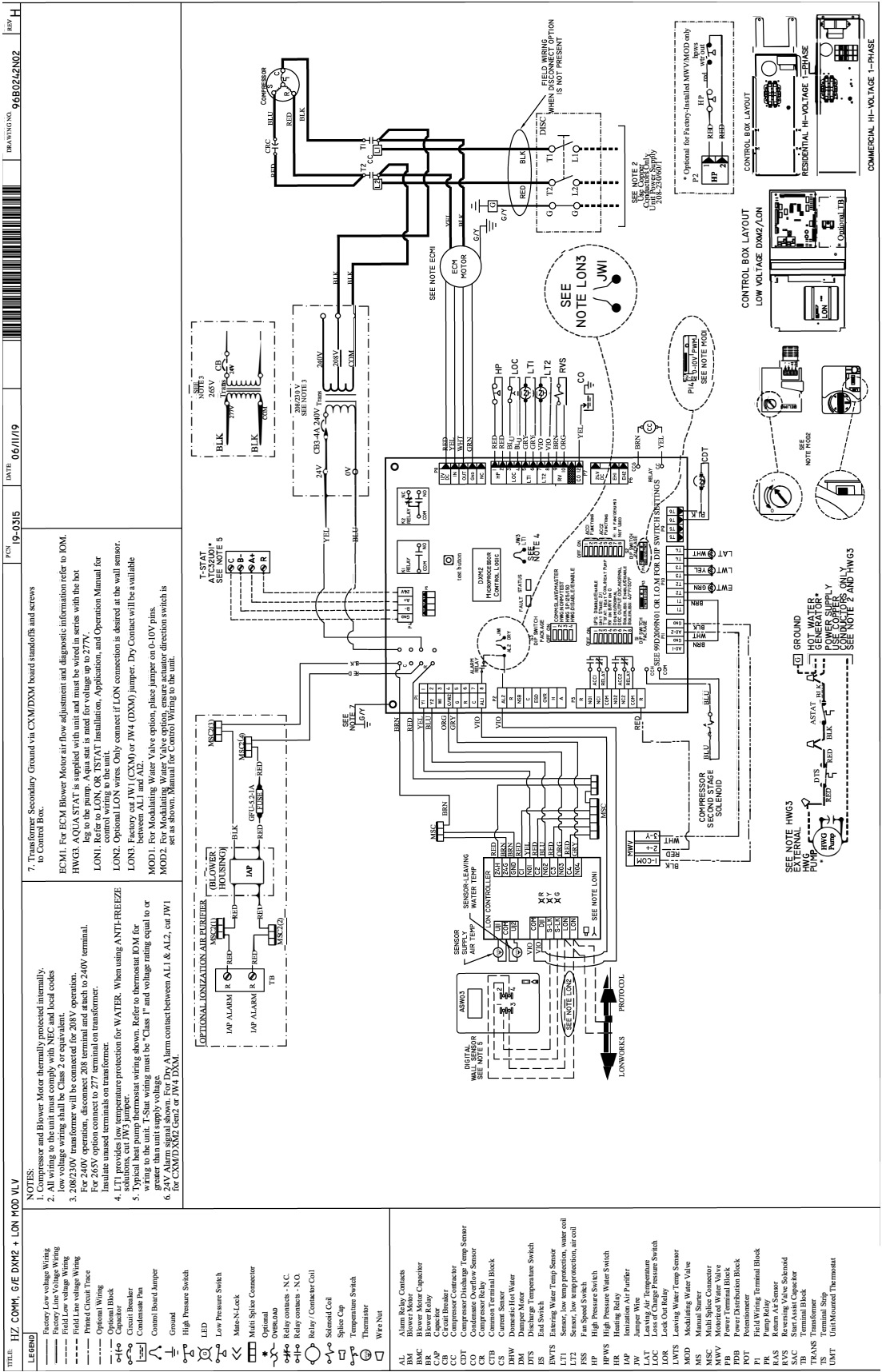

## HZ Series 60Hz Engineering Specifications – Page 1

# NOTICE!

### HZD/H/V SIZE 024-070 60Hz ENGINEERING SPECIFICATIONS

#### **General:**

Furnish and install HZ Water Source Heat Pumps, as indicated on the plans. Equipment shall be completely assembled, piped, and internally wired. Capacities and characteristics as listed in the schedule and the specifications that follow.

Units shall be supplied completely factory built capable of operating over an entering water temperature range from 20° to 120°F (-6.7° to 48.9°C) as standard. Equivalent units from other manufacturers may be proposed provided approval to bid is given 10 days prior to bid closing. All equipment listed in this section must be rated and certified in accordance with Air-Conditioning, Heating and Refrigeration Institute/International Standards Organization (AHRI/ISO 13256-1). All equipment must be tested, investigated, and determined to comply with the requirements of the standards for Heating and Cooling Equipment UL-1995 for the United States and CAN/CSA-C22.2 NO.236 for Canada, by Intertek Testing Laboratories (ETL). The units shall have AHRI/ISO and ETL-US-C labels.

All units shall pass a factory acceptance test. The quality control system shall automatically perform the factory acceptance test via computer. A detailed report card from the factory acceptance test shall ship with each unit. (Note: If unit fails the factory acceptance test it shall not be allowed to ship. Unit serial number will be recorded by factory acceptance test and furnished on report card for ease of unit warranty status.)

#### **Basic Construction:**

Horizontal units shall have one of the following air flow arrangements: Left Inlet/Straight (Right) Discharge; Right Inlet/Straight (Left) Discharge; Left Inlet/Back Discharge; or Right Inlet/Back Discharge as shown on the plans. Units must have the ability to be field convertible from straight to back or back to straight discharge with no additional parts or unit structure modification. Horizontal units will have factory installed hanger brackets with rubber isolation grommets packaged separately.

Vertical Units shall have one of the following air flow arrangements: Left Return/Top Discharge, Right Return/Top Discharge, Left Return/Bottom Discharge, Right Return/Bottom Discharge as shown on the plans.

If units with these arrangements are not used, the contractor is responsible for any extra costs incurred by other trades. All units (horizontal and vertical) must have a minimum of three access panels for serviceability of compressor compartment. Units having only one access panel to compressor/heat exchangers/expansion device/refrigerant piping shall not be acceptable.

Compressor section interior surfaces shall be lined with 1/2 inch (12.7mm) thick, 1-1/2 lb/ft<sup>3</sup> (24 kg/m<sup>3</sup>) acoustic type glass fiber insulation. Air handling section interior surfaces shall be lined with 1/2 in (12.7mm) thick, 1-1/2 lb/ft<sup>3</sup> (24 kg/m<sup>3</sup>) foil-faced fiber insulation for ease of cleaning. Insulation placement shall be designed in a manner that will eliminate any exposed edges to prevent the introduction of glass fibers into the air stream. Units without foil-faced insulation in the air handling section will not be accepted.

The heat pumps shall be fabricated from heavy gauge galvanized steel with powder coat paint finish. Both sides of the steel shall be painted for added protection.

Standard cabinet panel insulation must meet NFPA 90A requirements, air erosion and mold growth limits of UL-181, stringent fungal resistance test per ASTM-C1071 and ASTM G21, and shall meet zero level bacteria growth per ASTM G22. Unit insulation must meet these stringent requirements or unit(s) will not be accepted.

All horizontal units to have factory installed 1”(25.4mm) discharge air duct collars, 1”(25.4mm) filter rails with 1”(25.4mm)

## HZ Series 60Hz Engineering Specifications – Page 2

filters factory installed, and factory installed unit-mounting brackets. Vertical units to have field installed discharge air duct collar, shipped loose and 1" (25.4mm) filter rails with 1" (25.4mm) filters factory installed. If units with these factory-installed provisions are not used, the contractor is responsible for any extra costs to field install these provisions, and/or the extra costs for his sub-contractor to install these provisions.

All units must have an insulated panel separating the fan compartment from the compressor compartment. Units with the compressor in the air stream are not acceptable. Units shall have a factory installed 1 inch (25.4mm) wide filter bracket for filter removal from either side. Units shall have a 1 inch (25.4mm) thick throwaway type glass fiber filter. The contractor shall purchase one spare set of filters and replace factory shipped filters on completion of start-up. Filters shall be standard sizes. If units utilize non-standard filter sizes then the contractor shall provide 12 spare filters for each unit.

Cabinets shall have separate holes and knockouts for entrance of line voltage and low voltage control wiring. All factory-installed wiring passing through factory knockouts and openings shall be protected from sheet metal edges at openings by plastic ferrules. Supply and return water connections shall be copper FPT fittings, and shall be securely mounted flush to the cabinet corner post allowing for connection to a flexible hose without the use of a back-up wrench. Water connections that protrude through the cabinet or require the use of a backup wrench shall not be allowed. All water connections and electrical knockouts must be in the compressor compartment corner post as to not interfere with the serviceability of unit. Contractor shall be responsible for any extra costs involved in the installation of units that do not have this feature. Contractor must ensure that units can be easily removed for servicing and coordinate locations of electrical conduit and lights with the electrical contractor.

**Option:** The unit will be supplied with optional field or factory installed 2" air filter rails (typically used for free return installation) or 1" or 2" air filter frames with filter access door and return air duct flanges (typically used for ducted return installation). A corresponding 1" or 2" throwaway type glass fiber filter will ship with the factory installed filter rails or frame.

**Option:** The contractor shall install 1 inch MERV 8, 2 inch MERV 11, or 2 inch MERV 13 rated pleated media disposable air filters on all units.

**Option:** UltraQuiet package shall consist of high technology sound attenuating material that is strategically applied to the compressor and air handling compartment casings and fan scroll in addition to the standard system design, to further dampen and attenuate sound transmissions.

**Option:** The unit will be supplied with internally factory mounted modulating water valve with delta T control. The factory built-in valve shall modulate water flow through unit based on a field adjustable water temperature difference between the entering and leaving water. For two stage units, the modulating valve will automatically reduce the water flow through the unit during part load operation to maintain the configured temperature difference. The valve shall automatically adjust for operating mode, stage of capacity, source water temperature and variations in external head pressure. The valve will also act as a shut-off valve to prevent water flow through the unit when the unit is not activated and will have a minimum position capability.

**Option:** The unit will be supplied with internally factory mounted variable speed water circulating pump with internal check valve. The variable speed pump shall modulate water flow through the unit based on a field adjustable temperature difference between the entering and leaving water. For two-stage units, the modulating valve will automatically reduce the water flow through the unit during part load operation to maintain the configured temperature difference. The variable speed pump shall automatically adjust for operating mode, stage of capacity, source water temperature, and variations in external head pressure.

## HZ Series 60Hz Engineering Specifications – Page 3

- Option:** The unit will be supplied with internally mounted secondary pump for primary/secondary applications, including one-pipe systems.
- Option:** The unit shall be supplied with extended range insulation option, which adds closed cell insulation to internal water lines, and provides insulation on suction side refrigeration tubing including refrigerant to water heat exchanger.
- Option:** Unit shall include ClimaDry® reheat option. Only modulating reheat that will adjust capacity based upon supply air temperature to provide “neutral” (72°F, 22.2°C) constant air temperature will be accepted. “Neutral” supply air temperature shall be provided regardless of entering loop water temperatures (above 55°F, 12.8°C) or refrigerant condensing pressures. Control of reheat must be accomplished via a humidistat or dehumidistat contact closure. Refrigerant circuit must be AHRI certified. Approved equal manufacturers may provide pre-engineered integrated modulating hot gas reheat within the unit cabinet, or the installing contractor in conjunction with the “approved equal” unit manufacturer can provide for approval (during the submittal phase) an engineered system consisting of: a duct mounted hot water coil, small circulating pump, modulating control valve, and associated piping using the discharge condenser water off of the unit as the heating medium. All design costs and costs of field installed items including additional power wiring to pump, and control wiring to and from pump and control valve to unit shall be borne by mechanical contractor. Refrigerant circuits are not AHRI certified when the reheat option is applied will not be accepted.

### Fan and Motor Assembly:

Blower shall have inlet rings to allow removal of wheel and motor from one side without removing housing. Units shall have a direct-drive centrifugal fan. The fan motor shall be an ECM variable speed ball bearing type motor. The ECM fan motor shall provide soft starting, maintain constant CFM over its static operating range and provide airflow adjustment in 25 CFM increments via its control board. The fan motor shall be isolated from the housing by rubber grommets. The motor shall be permanently lubricated and have thermal overload protection. A special dehumidification mode shall be provided to allow lower airflows in cooling for better dehumidification. The dehumidification mode may be constant or automatic (humidistat controlled). Airflow/Static pressure rating of the unit shall be based on a wet coil and a clean filter in place. Ratings based on a dry coil, and/or no air filter, shall NOT be acceptable.

### Refrigerant Circuit:

All units shall contain an EarthPure®(HFC-410A) sealed refrigerant circuit including a high efficiency two-stage scroll compressor designed for heat pump operation, a thermostatic expansion valve for refrigerant metering, an enhanced corrugated aluminum lanced fin and rifled copper tube or all aluminum micro channel refrigerant to air heat exchanger, reversing valve, coaxial (tube in tube) refrigerant to water heat exchanger, and safety controls including a high pressure switch, low pressure switch (loss of charge), water coil low temperature sensor, and air coil low temperature sensor. Access fittings shall be factory installed on high and low pressure refrigerant lines to facilitate field service. Activation of any safety device shall prevent compressor operation via a microprocessor lockout circuit. The lockout circuit shall be reset at the thermostat or at the contractor supplied disconnect switch. Units that cannot be reset at the thermostat shall not be acceptable.

Hermetic compressors shall be internally sprung. The compressor shall have a dual level vibration isolation system. The compressor will be mounted on specially engineered sound-tested EPDM vibration isolation grommets to a large heavy gauge compressor mounting plate, which is then isolated from the cabinet base with rubber grommets for maximized vibration attenuation. All units shall include a discharge muffler to further enhance sound attenuation. Compressor shall have thermal overload protection. Compressor shall be located in an insulated compartment away from air stream to minimize sound transmission.

## HZ Series 60Hz Engineering Specifications – Page 4

Refrigerant to air heat exchangers shall utilize enhanced corrugated lanced aluminum fins and rifled copper tube or all aluminum microchannel construction rated to withstand 625 PSIG (4309 kPa) refrigerant working pressure. Refrigerant to water heat exchangers shall be of copper inner water tube and steel refrigerant outer tube design, rated to withstand 625 PSIG (4309 kPa) working refrigerant pressure and 500 PSIG (3445 kPa) working water pressure. The refrigerant to water heat exchanger shall be “electro-coated” with a low cure cathodic epoxy material a minimum of 0.4 mils thick (0.4 – 1.5 mils range) on all surfaces. The black colored coating shall provide a minimum of 1000 hours salt spray protection per ASTM B117-97 on all external steel and copper tubing. The material shall be formulated without the inclusion of any heavy metals and shall exhibit a pencil hardness of 2H (ASTM D3363-92A), crosshatch adhesion of 4B-5B (ASTM D3359-95), and impact resistance of 160 in-lbs (184 kg-cm) direct (ASTM D2794-93).

Refrigerant metering shall be accomplished by thermostatic expansion valve only. Expansion valves shall be dual port balanced types with external equalizer for optimum refrigerant metering. Units shall be designed and tested for operating ranges of entering water temperatures from 20° to 120°F (-6.7° to 48.9°C). Reversing valve shall be four-way solenoid activated refrigerant valve, which shall default to heating mode should the solenoid fail to function. If the reversing valve solenoid defaults to cooling mode, an additional low temperature thermostat must be provided to prevent over-cooling an already cold room.

**Option:** The unit will be supplied with a cupro-nickel coaxial water to refrigerant heat exchanger.

**Option:** The unit shall be supplied with a hot water generator (desuperheater).

### Drain Pan:

The drain pan shall be constructed of Stainless Steel to inhibit corrosion. This corrosion protection system shall meet the stringent 1000 hour salt spray test per ASTM B117. If plastic type material is used, it must be HDPE (High Density Polyethylene) to avoid thermal cycling shock stress failure over the lifetime of the unit. Drain pan shall be fully insulated. Drain outlet shall be located at pan as to allow unobstructed drainage of condensate. Drain outlet for horizontal units shall be connected from pan directly to MPT fitting. No hidden internal tubing extensions from pan outlet extending to unit casing (that can create drainage problems) will be accepted. The unit as standard will be supplied with solid-state electronic condensate overflow protection. **Mechanical float switches will NOT be accepted.**

Vertical units shall be furnished with a PVC FPT condensate drain connection and an internal factory installed condensate trap. If units without an internal trap are used, the contractor is responsible for any extra costs to field install these provisions, and/or the extra costs for his sub-contractor to install these provisions.

### Electrical:

A control box shall be located within the unit compressor compartment and shall contain a 75VA transformer, 24 volt activated, 2 or 3 pole compressor contactor, terminal block for thermostat wiring and solid-state controller for complete unit operation. Reversing valve and fan motor wiring shall be routed through this electronic controller. Units shall be name-plated for use with time delay fuses or HACR circuit breakers. Unit controls shall be 24 Volt and provide heating or cooling as required by the remote thermostat/sensor.

**Option:** Units shall be supplied with factory installed non-fused electrical service disconnect switch.

### Solid State Control System (DXM2):

Units shall have a solid-state control system. Units utilizing electro-mechanical control shall not be acceptable. The control system microprocessor board shall be specifically designed to protect against building electrical system noise contamination, EMI, and RFI interference. The control system shall have the following features:

- Anti-short cycle time delay on compressor operation.

# HZ Series 60Hz

## Engineering Specifications – Page 5

- Random start on power up mode.
- Low voltage protection.
- High voltage protection.
- Unit shutdown on high or low refrigerant pressures (loss of charge).
- Unit shutdown on low water temperature.
- Condensate overflow electronic protection.
- Option to reset unit at thermostat or disconnect.
- Automatic intelligent reset. Unit shall automatically reset the unit 5 minutes after trip if the fault has cleared. If a fault occurs 3 times sequentially without thermostat meeting temperature, then lockout requiring manual reset will occur.
- Ability to defeat time delays for servicing.
- Light emitting diode (LED) on circuit board to indicate high pressure, low pressure (loss of charge), low voltage, high voltage, low water/air temperature cut-out, condensate overflow, and control voltage status.
- The low-pressure (loss of charge) switch shall not be monitored for the first 120 seconds after a compressor start command to prevent nuisance safety trips.
- 24V output to cycle a motorized water valve or other device with compressor contactor.
- Unit Performance Sentinel (UPS). The UPS warns when the heat pump is running inefficiently.
- Water coil low temperature sensing (selectable for water or antifreeze).
- Air coil low temperature sensing.
- Removable thermostat connector.
- Night setback control.
- Random start on return from night setback.
- Minimized reversing valve operation (Unit control logic shall only switch the reversing valve when cooling is demanded for the first time. The reversing valve shall be held in this position until the first call for heating, ensuring quiet operation and increased valve life.).
- Override temperature control with 2-hour timer for room occupant to override setback temperature at the thermostat.
- Dry contact night setback output for digital night setback thermostats.
- Ability to work with heat pump (Y, O) or heat/cool (Y, W) type thermostats.
- Ability to work with heat pump thermostats using O or B reversing valve control.
- Emergency shutdown contacts.
- Boilerless system heat control at low loop water temperature.
- Ability to allow up to 3 units to be controlled by one thermostat.
- Relay to operate an external damper.
- Ability to automatically change fan speed from multistage thermostat.
- Relay to start system pump.
- 75 VA control transformer. Control transformer shall have load side short circuit and overload protection via a built in circuit breaker.

**NOTE: Units not providing the 8 safety protections of anti-short cycle, low voltage, high voltage, high refrigerant pressure, low pressure (loss of charge), air coil low temperature cut-out, water coil low temperature cut-out, and condensate overflow protections will not be accepted.**

**Note: To achieve full benefit of the two-stage compressor and ECM fan, a 2 Heat/2 Cool thermostat (or a 3 Heat/2 Cool thermostat when electric backup heat is required) should be employed.**

### Digital Night Setback with Pump Restart

The unit will be provided with a Digital Night Setback feature using an accessory relay on the DXM2 controller and an external, field-provided time clock. The external time clock will initiate and terminate the night setback period. The thermostat will have a night setback override feature with a programmable override time period.

An additional accessory relay on the unit DXM2 controller will energize the building loop pump control for the duration of the override period. (Note: this feature requires additional low voltage wiring. Consult Application Drawings for details.)



## HZ Series 60Hz Engineering Specifications – Page 6

### Remote Service Sentinel:

Solid state control system shall communicate with thermostat to display (at the thermostat) the unit status, fault status, and specific fault condition, as well as retrieve previously stored fault that caused unit shutdown. The Remote Service Sentinel allows building maintenance personnel or service personnel to diagnose unit from the wall thermostat. The control board shall provide a signal to the thermostat fault light, indicating a lockout. Upon cycling the G (fan) input 3 times within a 60 second time period, the fault light shall display the specific code as indicated by a sequence of flashes. A detailed flashing code shall be provided at the thermostat LED to display unit status and specific fault status such as over/under voltage fault, high pressure fault, low pressure fault, low water temperature fault, condensate overflow fault, etc. Units that do not provide this remote service sentinel shall not be acceptable.

### Option: Lonworks interface system

Units shall have all the features listed above and the control board will be supplied with a LONWORKS interface board, which is LONMark certified. This will permit all units to be daisy chained via a 2-wire twisted pair shielded cable. The following points must be available at a central or remote computer location:

- a. space temperature
- b. leaving water temperature
- c. discharge air temperature
- d. command of space temperature setpoint
- e. cooling status
- f. heating status
- g. low temperature sensor alarm
- h. low pressure sensor alarm
- i. high pressure switch alarm
- j. condensate sensor alarm
- k. hi/low voltage alarm
- l. fan "ON/AUTO" position of space thermostat as specified above
- m. unoccupied/occupied command
- n. cooling command
- o. heating command
- p. fan "ON/AUTO" command
- q. fault reset command
- r. itemized fault code revealing reason for specific shutdown fault (any one of 7)

### Option: MPC (Multiple Protocol Control) interface system

Units shall have all the features listed above and the control board will be supplied with a Multiple Protocol interface board. Available protocols are BACnet MS/TP, Modbus, or Johnson Controls N2. The choice of protocol shall be field selectable/changeable via the use of a simple selector switch. Protocol selection shall not require any additional programming or special external hardware or software tools. This will permit all units to be daisy chain connected by a 2-wire twisted pair shielded cable. The following points must be available at a central or remote computer location:

- a. space temperature
- b. leaving water temperature
- c. discharge air temperature
- d. command of space temperature setpoint
- e. cooling status
- f. heating status
- g. low temperature sensor alarm
- h. low pressure sensor alarm
- i. high pressure switch alarm
- j. condensate overflow alarm
- k. hi/low voltage alarm

# HZ Series 60Hz Engineering Specifications – Page 7

- l. fan "ON/AUTO" position of space thermostat as specified above
- m. unoccupied/occupied command
- n. cooling command
- o. heating command
- p. fan "ON/AUTO" command
- q. fault reset command
- r. itemized fault code revealing reason for specific shutdown fault (any one of 7)

## FIELD INSTALLED OPTIONS

### Hose Kits:

All units shall be connected with hoses. The hoses shall be 2 feet (61cm) long, braided stainless steel; fire rated hoses complete with adapters. Only fire rated hoses will be accepted.

### Valves:

The following valves are available and will be shipped loose:

- a. Ball valve; bronze material, standard port full flow design, FPT connections.
- b. Ball valve with memory stop and PT port.
- c. "Y" strainer with blowdown valve; bronze material, FPT connections.
- d. Motorized water valve; slow acting, 24v, FPT connections.

### Hose Kit Assemblies:

The following assemblies ship with the valves already assembled to the hose described:

- a. Supply and return hoses having ball valve with PT port.
- b. Supply hose having ball valve with PT port; return hose having automatic flow regulator valve with PT ports, and ball valve.
- c. Supply hose having "Y" strainer with blowdown valve, and ball valve with PT port; return hose having automatic flow regulator with PT ports, and ball valve.
- d. Supply hose having "Y" strainer with blowdown valve, and ball valve with PT port; return hose having ball valve with PT port.

### Thermostats:

The thermostat shall be a mechanical or electronic type thermostat as selected below with the described features:

- a. Thermostat (communicating) (7602-457)

An electronic communicating LCD thermostat shall be provided. The thermostat shall offer three stages of heating and two stages of cooling with precise temperature control and have a four-wire connection to the unit. The thermostat shall be capable of manual or automatic change-over operation and shall operate in standard or programmable mode. An integrated humidity control feature shall be included to control a humidifier and/or a dehumidifier. The thermostat shall include a utility demand reduction feature to be initiated by an independent time program or an external input.

The thermostat shall have a comprehensive installation setup menu to include configuration of the unit CFM for each mode of operation and configuration of the water flow rate through the unit, including variation of the water flow rate based on the stage of unit operation.

The thermostat shall display system faults with probable cause and troubleshooting guidance. Comprehensive service diagnostics menus shall display, system inputs, system outputs, configuration settings, Geo source inlet and outlet temperatures, compressor discharge line temperature, liquid line temperature, leaving air temperature, and entering

## HZ Series 60Hz Engineering Specifications – Page 8

potable water temperature (on units equipped with a Hot Water Generator). The thermostat shall allow for immediate manual control of all DXM2 outputs at the thermostat for rapid troubleshooting.

b. Multistage Digital Automatic Changeover

Thermostat shall be multi-stage (2H/2C), manual or automatic changeover with HEAT-OFF-COOL-AUTO-EM HEAT system settings and fan ON-AUTO settings. Thermostat shall have an LCD display with temperature, setpoint(s), mode, and status indication. The temperature indication shall be selectable for °F or °C. The thermostat shall provide permanent memory of setpoint(s) without batteries. A fault LED shall be provided to indicate specific fault condition(s). Thermostat shall provide temperature display offset for custom applications. Thermostat shall allow unit to provide better dehumidification by automatically using lower fan speed on stage 1 cooling (higher latent cooling) as main cooling mode, and automatically shifting to high speed fan on stage 2 cooling.

c. Multistage Automatic or Manual Changeover Programmable 7 Day

Thermostat shall be 7 day programmable (with up to 4 setpoints per day), multi-stage (3H/2C), automatic or manual changeover with HEAT-OFF-COOL-AUTO-EM HEAT system settings and fan ON-AUTO settings. Thermostat shall have a blue backlit dot matrix LCD display with temperature, setpoints, mode, and status indication. The temperature indication shall be selectable for °F or °C. Time display shall be selectable for 12 or 24 hour clock. Fault identification shall be provided to simplify troubleshooting by providing specific unit fault at the thermostat with red backlit LCD during unit lockout. The thermostat shall provide permanent memory of setpoints without batteries. Thermostat shall provide heating setpoint range limit, cooling setpoint range limit, temperature display offset, keypad lockout, dead-band range setting, and inter-stage differential settings. Thermostat shall provide progressive recovery to anticipate time required to bring space temperature to the next programmed event. Thermostat shall provide an installer setup for configuring options and for setup of servicing contractor name and contact information. Thermostat shall allow the use of an accessory remote and/or outdoor temperature sensor (AST008). Thermostat navigation shall be accomplished via five buttons (up/down/right/left/select) with menu-driven selections for ease of use and programming.

d. Multistage Automatic or Manual Changeover Programmable 7 Day with Humidity Control

Thermostat shall be 7 day programmable (with up to 4 setpoints per day), multi-stage (3H/2C), automatic or manual changeover with HEAT-OFF-COOL-AUTO-EM HEAT system settings and fan ON-AUTO settings. Separate dehumidification and humidification setpoints shall be configurable for discreet outputs to a dehumidification option and/or an external humidifier. Installer configuration mode shall allow thermostat to operate with ECM fan dehumidification mode via settings changes. Thermostat shall have a blue backlit dot matrix LCD display with temperature, relative humidity, setpoints, mode, and status indication. The temperature indication shall be selectable for °F or °C. Time display shall be selectable for 12 or 24 hour clock. Fault identification shall be provided to simplify troubleshooting by providing specific unit fault at the thermostat with red backlit LCD during unit lockout. The thermostat shall provide permanent memory of setpoints without batteries. Thermostat shall provide heating setpoint range limit, cooling setpoint range limit, temperature display offset, keypad lockout, dead-band range setting, and inter-stage differential settings. Thermostat shall provide progressive recovery to anticipate time required to bring space temperature to the next programmed event. Thermostat shall provide an installer setup for configuring options and for setup of servicing contractor name and contact information. Thermostat shall allow the use of an accessory remote and/or outdoor temperature sensor (AST008). Thermostat navigation shall be accomplished via five buttons (up/down/right/left/select) with menu-driven selections for ease of use and programming.

## Tranquility® 30 (TE) Series 60Hz Engineering Specifications – Page 9

### **DDC Sensors:**

Wall mounted DDC sensor to monitor room temperature and interfaces with optional interface system described above. Several types as described below:

- a. Sensor only with no display (LON and MPC).
- b. Sensor with override (LON only).
- c. Sensor with setpoint adjustment and override (MPC only).
- d. Sensor with setpoint adjustment and override, LCD display, status/fault indication (LON and MPC).

### **Accessory:**

Hand Held Communication/Diagnostic Service Tool 7602-444

Allows installation and service personnel to access the configuration and service modes of the DXM2 control board without installing the 7602-457 communicating thermostat.

Configure the airflow, pump, or modulating valve operation etc.

Diagnose by viewing fault history and operating conditions at the time of fault and manually operating the unit.

## Performance Sheet

### SUBMITTAL DATA - S-I UNITS

Unit Designation: \_\_\_\_\_

Job Name: \_\_\_\_\_

Architect: \_\_\_\_\_

Engineer: \_\_\_\_\_

Contractor: \_\_\_\_\_

### PERFORMANCE DATA

Cooling Capacity: \_\_\_\_\_ kW

EER: \_\_\_\_\_

Heating Capacity: \_\_\_\_\_ kW

COP: \_\_\_\_\_

Ambient Air Temp: \_\_\_\_\_ °C

Entering Water Temp (Clg): \_\_\_\_\_ °C

Entering Air Temp (Clg): \_\_\_\_\_ °C

Entering Water Temp (Htg): \_\_\_\_\_ °C

Entering Air Temp (Htg): \_\_\_\_\_ °C

Airflow: \_\_\_\_\_ l/s

Fan Speed or Motor/RPM/Turns: \_\_\_\_\_

Operating Weight: \_\_\_\_\_ (kg)

### ELECTRICAL DATA

Power Supply: \_\_\_\_\_ Volts

\_\_\_\_\_ Phase \_\_\_\_\_ Hz

Minimum Circuit Ampacity: \_\_\_\_\_

Maximum Overcurrent Protection: \_\_\_\_\_

### SUBMITTAL DATA - I-P UNITS

Unit Designation: \_\_\_\_\_

Job Name: \_\_\_\_\_

Architect: \_\_\_\_\_

Engineer: \_\_\_\_\_

Contractor: \_\_\_\_\_

### PERFORMANCE DATA

Cooling Capacity: \_\_\_\_\_ Btuh

EER: \_\_\_\_\_

Heating Capacity: \_\_\_\_\_ Btuh

COP: \_\_\_\_\_

Ambient Air Temp: \_\_\_\_\_ °F

Entering Water Temp (Clg): \_\_\_\_\_ °F

Entering Air Temp (Clg): \_\_\_\_\_ °F

Entering Water Temp (Htg): \_\_\_\_\_ °F

Entering Air Temp (Htg): \_\_\_\_\_ °F

Airflow: \_\_\_\_\_ CFM

Fan Speed or Motor/RPM/Turns: \_\_\_\_\_

Operating Weight: \_\_\_\_\_ (lb)

### ELECTRICAL DATA

Power Supply: \_\_\_\_\_ Volts

\_\_\_\_\_ Phase \_\_\_\_\_ Hz

Minimum Circuit Ampacity: \_\_\_\_\_

Maximum Overcurrent Protection: \_\_\_\_\_

# Notes

# Revision History

Date:	Item:	Action:
07/25/19	Pages 66, 68, 69	Updated 7602-457
01/30/19	Page 36, 54	Updated variable pump data
11/7/18	Decoder	Updated water circuit options
07/14/17	ClimaDry II	Added
06/7/17	Dimension H Page 43	Updated
05/03/17	Vertical Upflow Models Dimensional Drawing	Updated
05/03/17	Vertical Upflow Models Water Connections Table	Updated
11/1/16	Update Design Document	Updated
03/12/16	Page 57 and 58	Update run test and vflow text
11/09/15	Unit Features and Engineering Specifications - Page 58	Update UltraQuiet Option Description
07/31/15	Unit Features and Engineering Specifications	Edit Compressor Mount Text
07/09/15	WPD - Page 16, 17, 18	Updated
01/30/15	Table edit - Page 39	Updated
11/21/14	Text edit - Page 7	Updated
10/20/14	TE026 Full Load Data	Updated
09/30/14	Decoder - Page 10; Text Edit - Page 59	Updated
09/10/14	Added Performance Data Selection Notes - Page 12 Updated Performance Data Notes - Pages 13-32	Added/Updated
07/28/14	Created	

Due to ongoing product improvements, specifications and dimensions are subject to change and correction without notice or incurring obligations. Determining the application and suitability for use of any product is the responsibility of the installer. Additionally, the installer is responsible for verifying dimensional data on the actual product prior to beginning any installation preparations.

Incentive and rebate programs have precise requirements as to product performance and certification. All products meet applicable regulations in effect on date of manufacture; however, certifications are not necessarily granted for the life of a product. Therefore, it is the responsibility of the applicant to determine whether a specific model qualifies for these incentive/rebate programs.

*Comfort-Aire*®  **Century**®

1900 Wellworth Ave., Jackson, MI 49203 • Ph. 517-787-2100 • [www.marsdelivers.com](http://www.marsdelivers.com)

